

Dentech the solution is in Your hand!



DENTECH

2013

DENTAL CATALOGUE

www.dentech.hu

FOGSZONDÁK - ZAHNSONDEN - EXPLORERS



.../HG



DA 1409



DA 1402

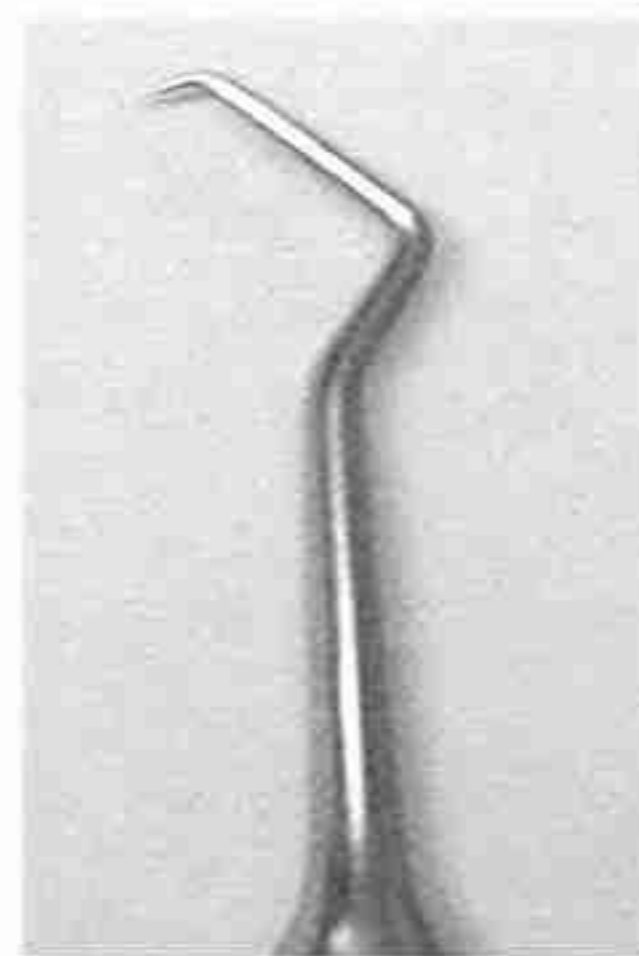

DA 1412

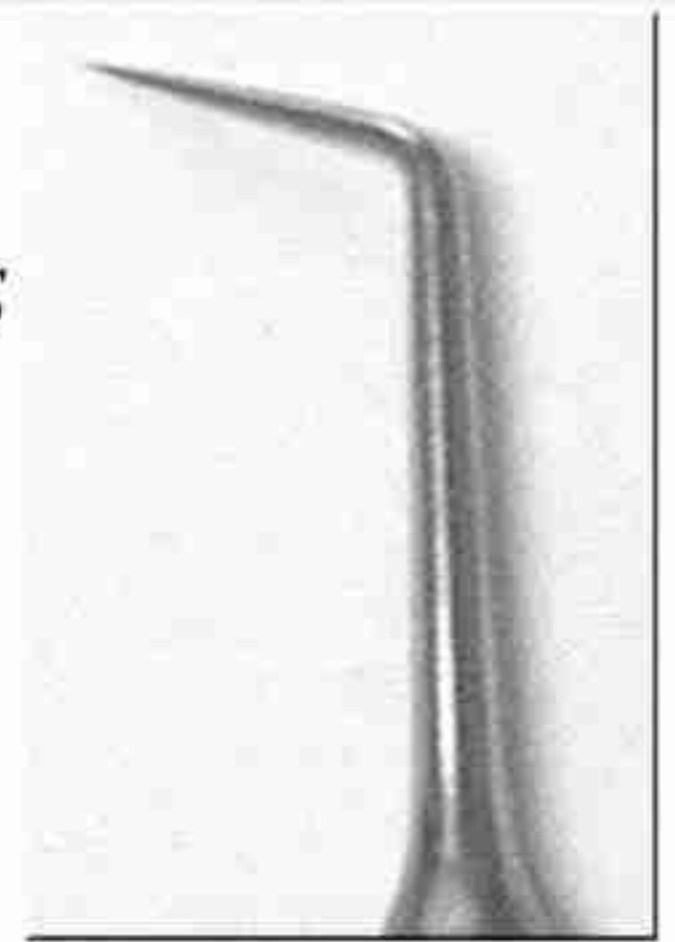

DA 1406

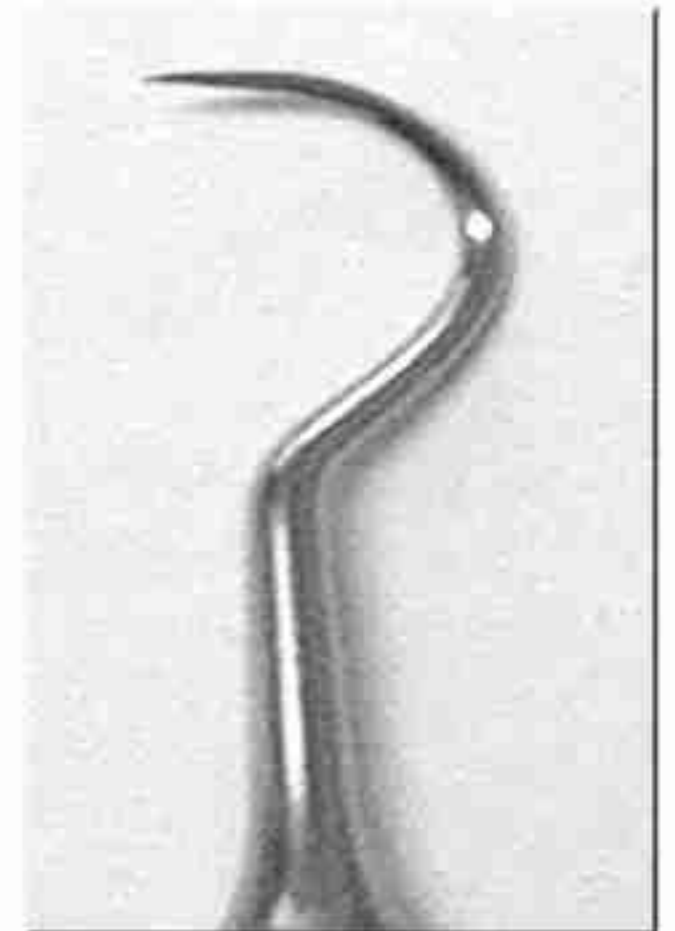

DA 1418

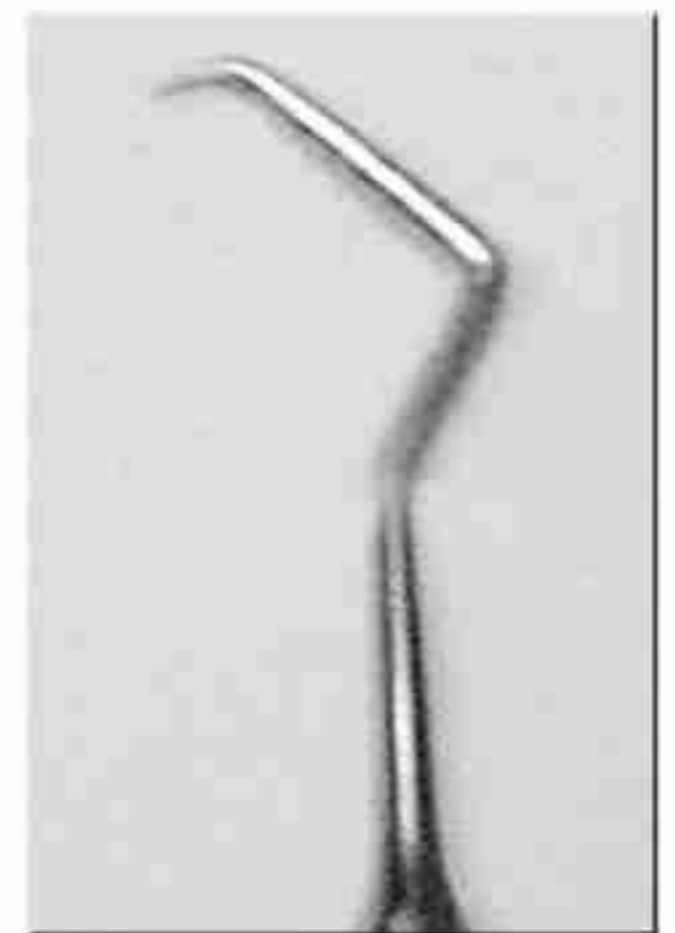

DA1414

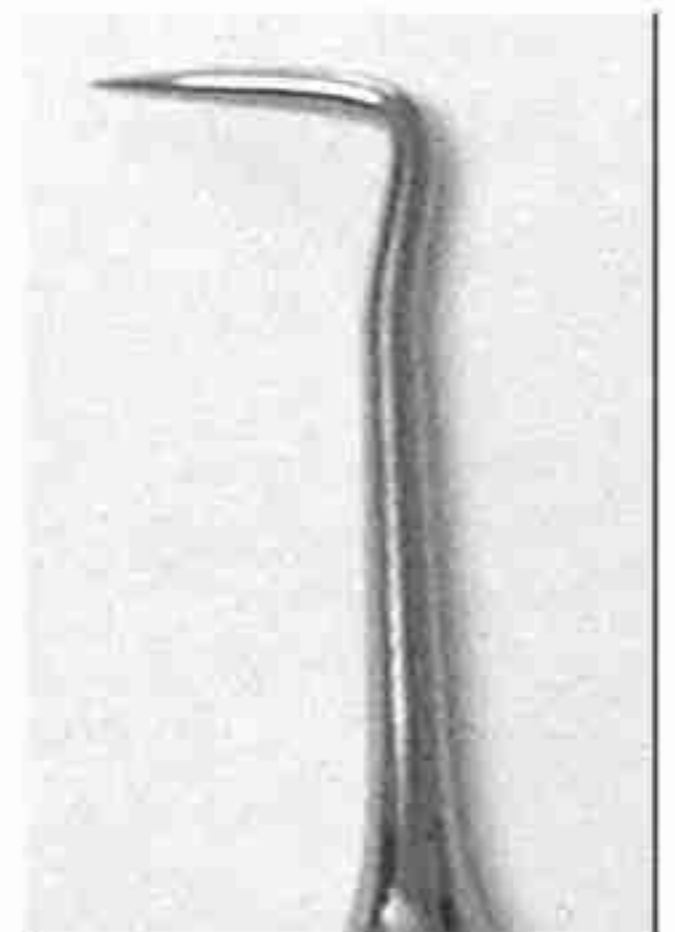

DA1408

FOGTÜKÖR - MUNDSPIEGEL - MOUTH MIRROR



DA 181 DA 180
FOGTÜKÖRNYÉL
MUNDSPIEGELGRIF
MIRROR HANDLE
13.5cm



SÍK -
PLAN -
PLANE

DA 125

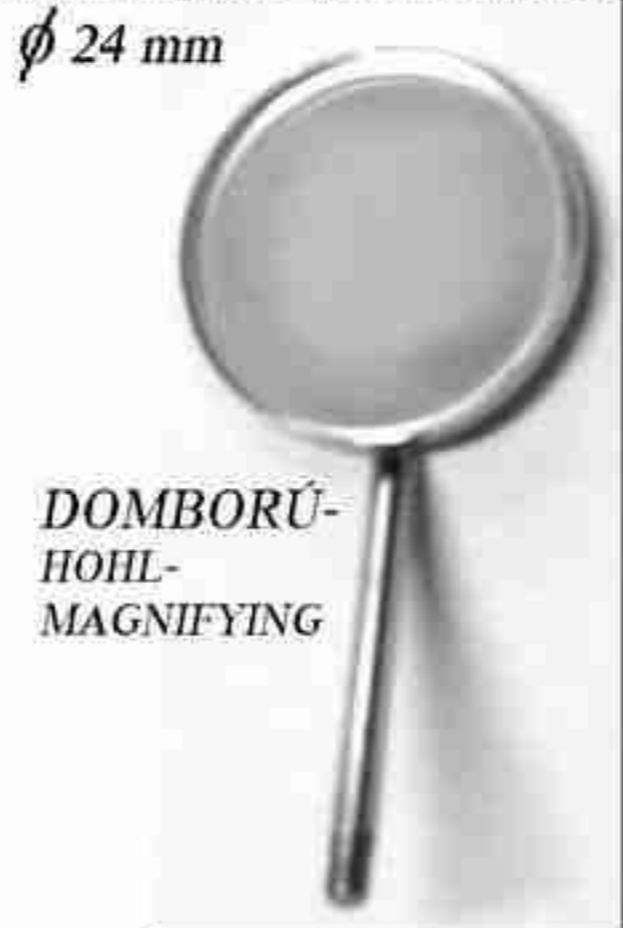

DOMBORÚ-
HOHL-
MAGNIFYING

DA 135

∅ 24 mm

∅ 24 mm

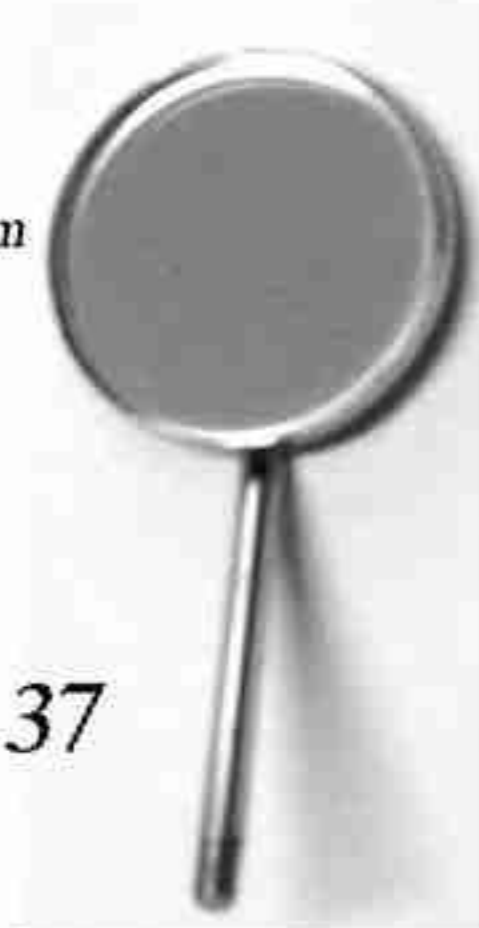

DA 137

RHÓDIUM TÜKÖR ,SÍK
MUNDSPIEGEL RHODIUM,PLAN
MOUTHMIRROR RHODIUM,PLANE

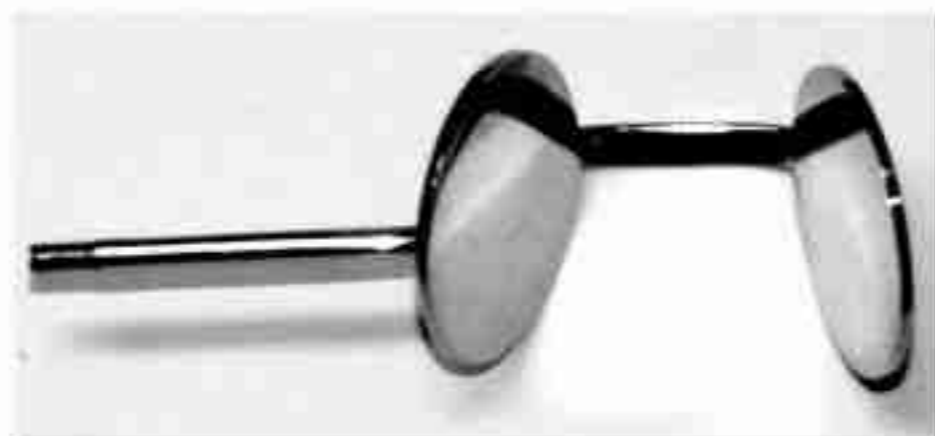

DA 136 KREUTER

KETTÓS TÜKÖR , FÉM
DOPPELSPIEGEL METALL ROSTFREI
DOUBLE MIRROR STAINLESS STEEL

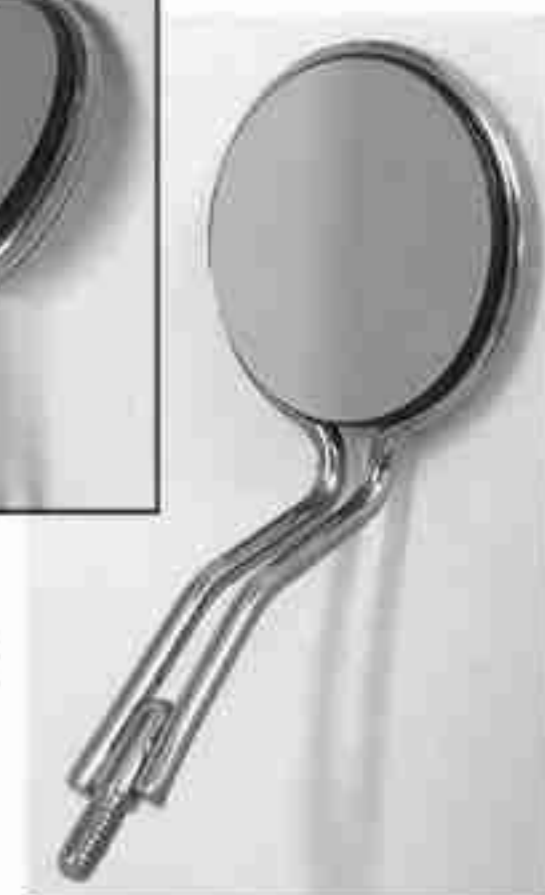

DA 138

RHÓDIUM TÜKÖR DUPLA
MUNDSPIEGEL RHODIUM DOPELTE
MOUTHMIRROR RHODIUM DOUBLE

INTRAORÁLIS TÜKÖR
INTRAORAL-SPIEGEL
INTRAORAL MIRROR

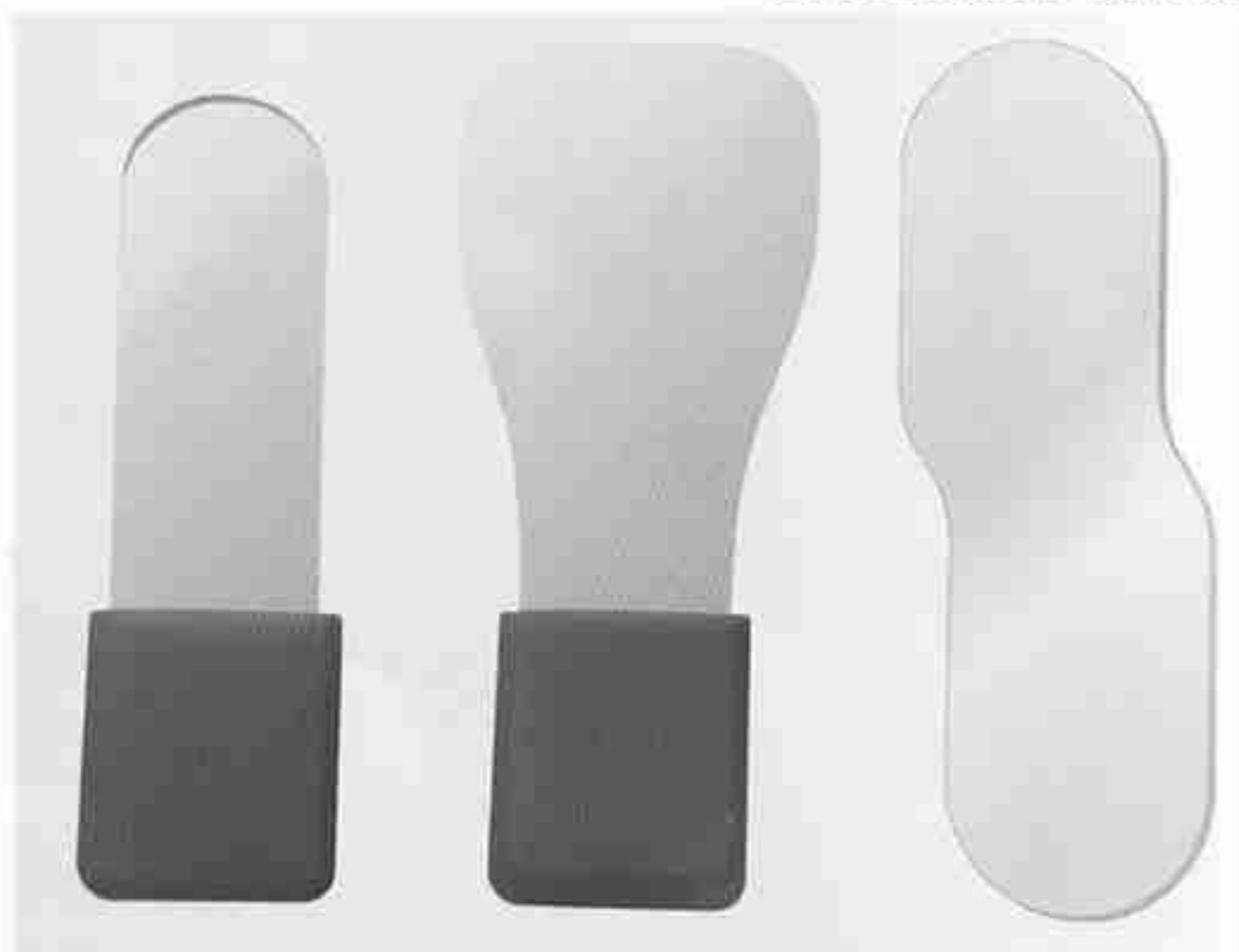

DA 140
Nr 60

DA 141
Nr 70

DA 142
Nr 80



DA 139

FRONT TÜKÖR
MUNDSPIEGEL FRONT
MOUTHMIRROR ,FRONT



DB 1768

DB 1769

WHO

DB 1766
TASAKMÉRŐ SZONDA
PARODONTOMETER
PERIODONTOMETER



SZIKENYÉL
SKALPELL GRIFF
SCALPEL HANDLE

BB 173

PENGEMÉRET 6-16
FÜR KLINGEN 6-16
BLADES 6-16

BB 184

PENGEMÉRET 18-36
FÜR KLINGEN 18-36
BLADES 18-36

KENDŐCSIPESZ
TUCHKLEMME
TOWEL CLAMPS

Schaedel
8,7 cm

BF 1411



KENDŐFOGÓ
TUCHKLEMME
TOWEL CLAMPS

Backhaus
11 cm

BF 1432

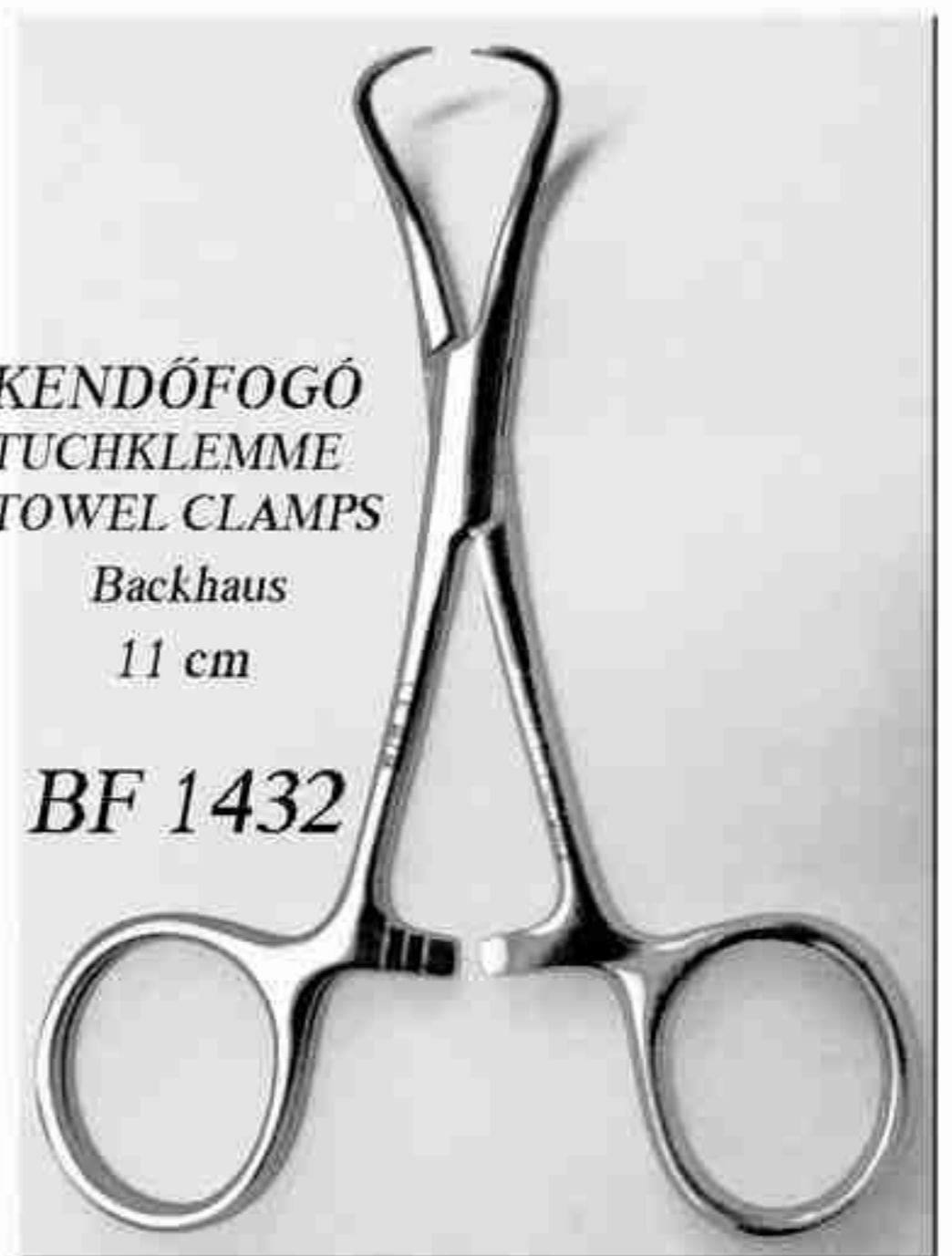

FOGÁSZATI CSIPESZEK - ZAHNPINZETTEN - TWEEZERS 16 cm



DA 1221



DA 1225

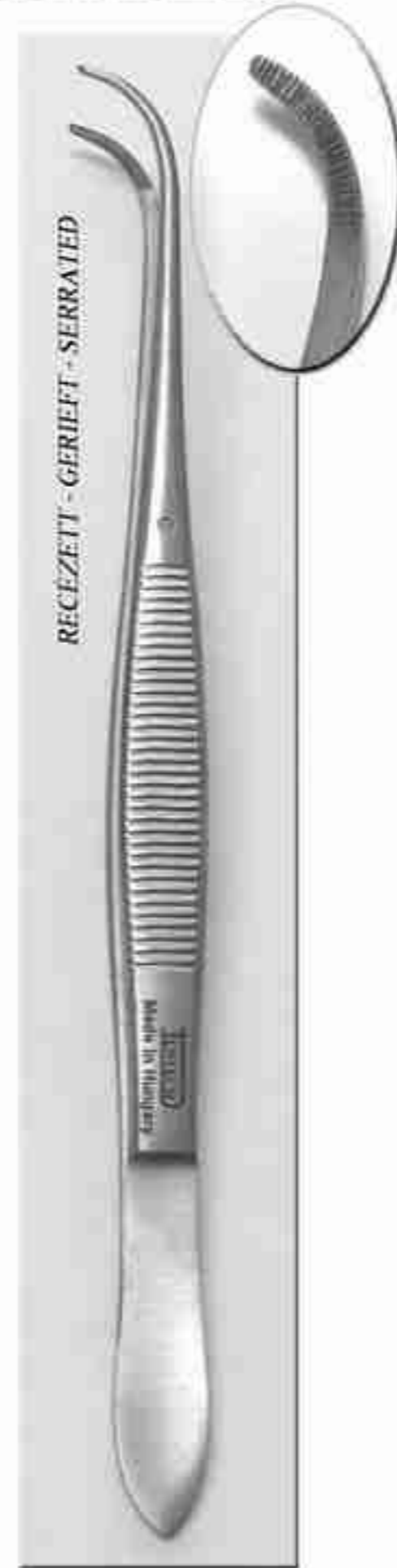

DA 1251



DA 1257



DA 1210



DA 1212



DA 1271

ZÁRAS FOGCSIPESZ - ZAHNPINZETTE
MIT SCHLÖß- TOOTH TWEEZERS
WITH LOCH



DA 1290

GYÖKÉRCsapcsipesz - ZAHNWURZELPINZETTEN
PIN HOLDING TWEEZERS



DA 1291

ARTIKULÁCIÓS PAPIRCsIPESZ - ARTIKULATIONSPAPIER-PINZETTEN
FORCEPS FOR ARTICULATING PAPER



DR 1780

FOGÁSZATI CSIPESZEK - ZAHNPINZETTEN - TWEEZERS 15 cm



DA 2220



DA 2221



DA 2225



DA 2251

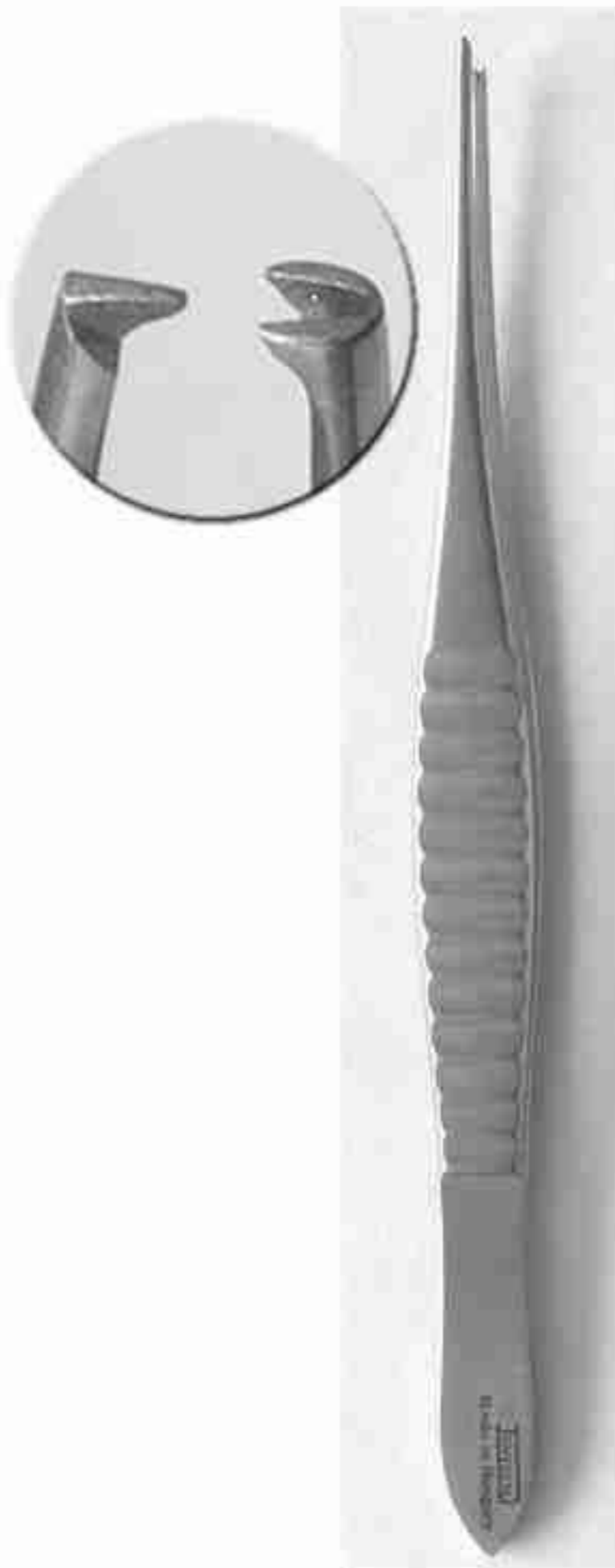

HORGAS CSIPESZEK FINOM-
FEINE HAKENPINZETTE -
DELICATE TISSUE FORCEPS



BD 1669

BD 1670

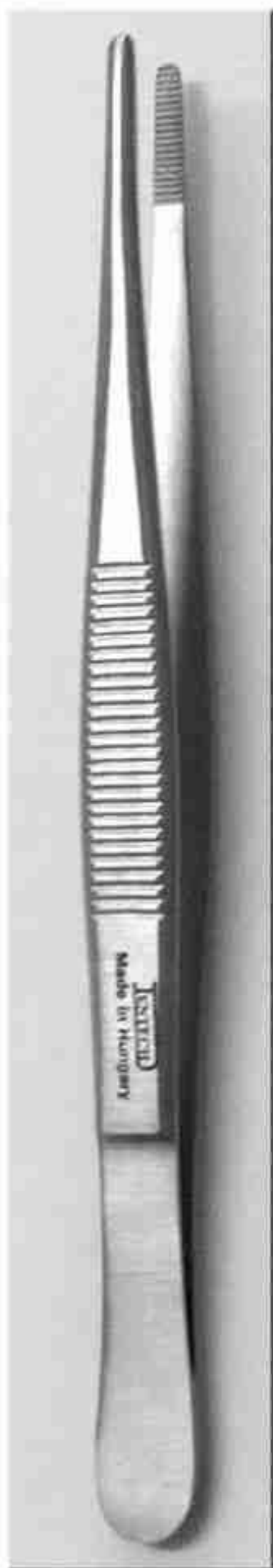
ANATÓMIAI CSIPESZEK -
ANATOMISCHE PITZETTE -
DRESSING AND DISSECTING FORCEPS

BD 143	11.5 cm
BD 145	13 cm
BD 147	14.5 cm
BD 149	16 cm
BD 150	18 cm
BD 151	20 cm
BD 152	25 cm
BD 153	30 cm

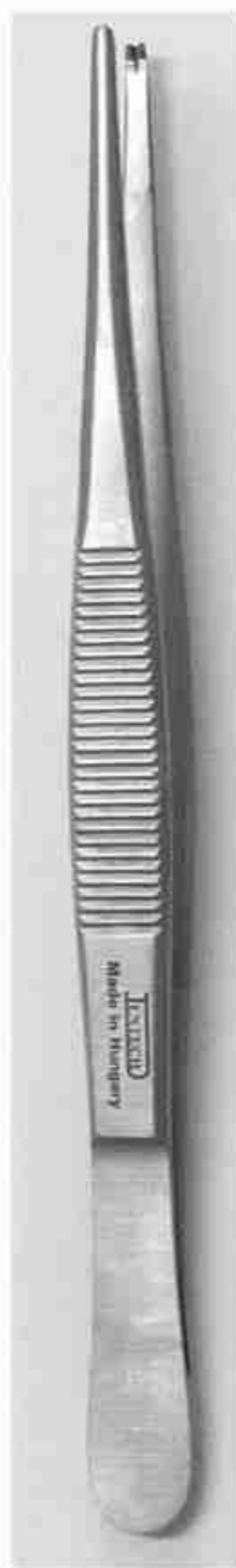

BD 1553	11.5cm
BD 1555	13 cm
BD 1557	14.5 cm
BD1559	16 cm

HORGAS CSIPESZEK -
HAKENPINZETTE -
TISSUE FORCEPS
1x2

BD 1000
11 cm
SZÁLKACSHIPESZ
SPLITTERPINZETTE
SPLINTER FORCEPS



DB 1939
ORBÁN PARADONTÁLIS KÉS
ORBÁN GINGIVECTOMY MESSER
ORBÁN GINGIVECTOMIEMESSER

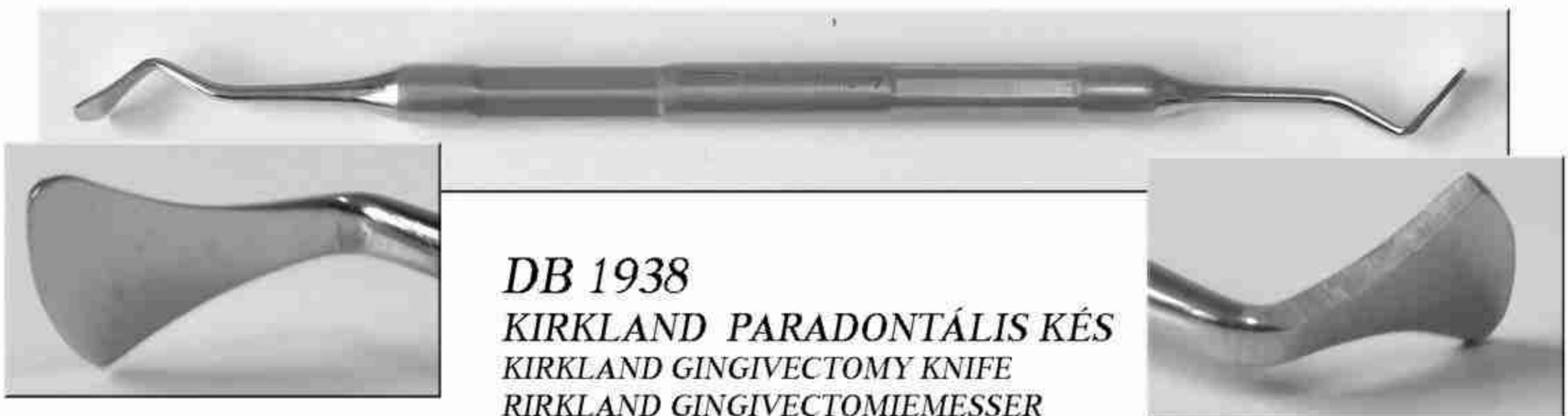

DB 1938
KIRKLAND PARADONTÁLIS KÉS
KIRKLAND GINGIVECTOMY KNIFE
RIRKLAND GINGIVECTOMIEMESSER

FOGÁSZATI KÜRETTEK "GRACEY" - ZAHNKÜRETTEN "GRACEY" - GRACEY CURETTES

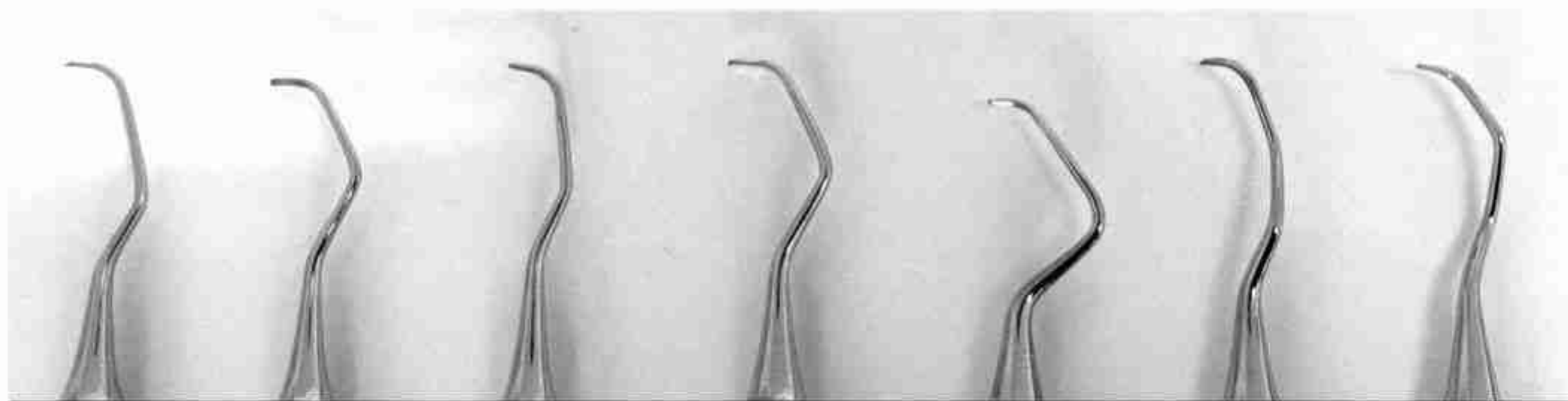

DB 1700

DB 1701

DB 1702

DB 1703

DB 1704

DB 1705

DB 1706

Fig. 1/2

Fig. 3/4

Fig. 5/6

Fig. 7/8

Fig. 9/10

Fig. 11/12

Fig. 13/14

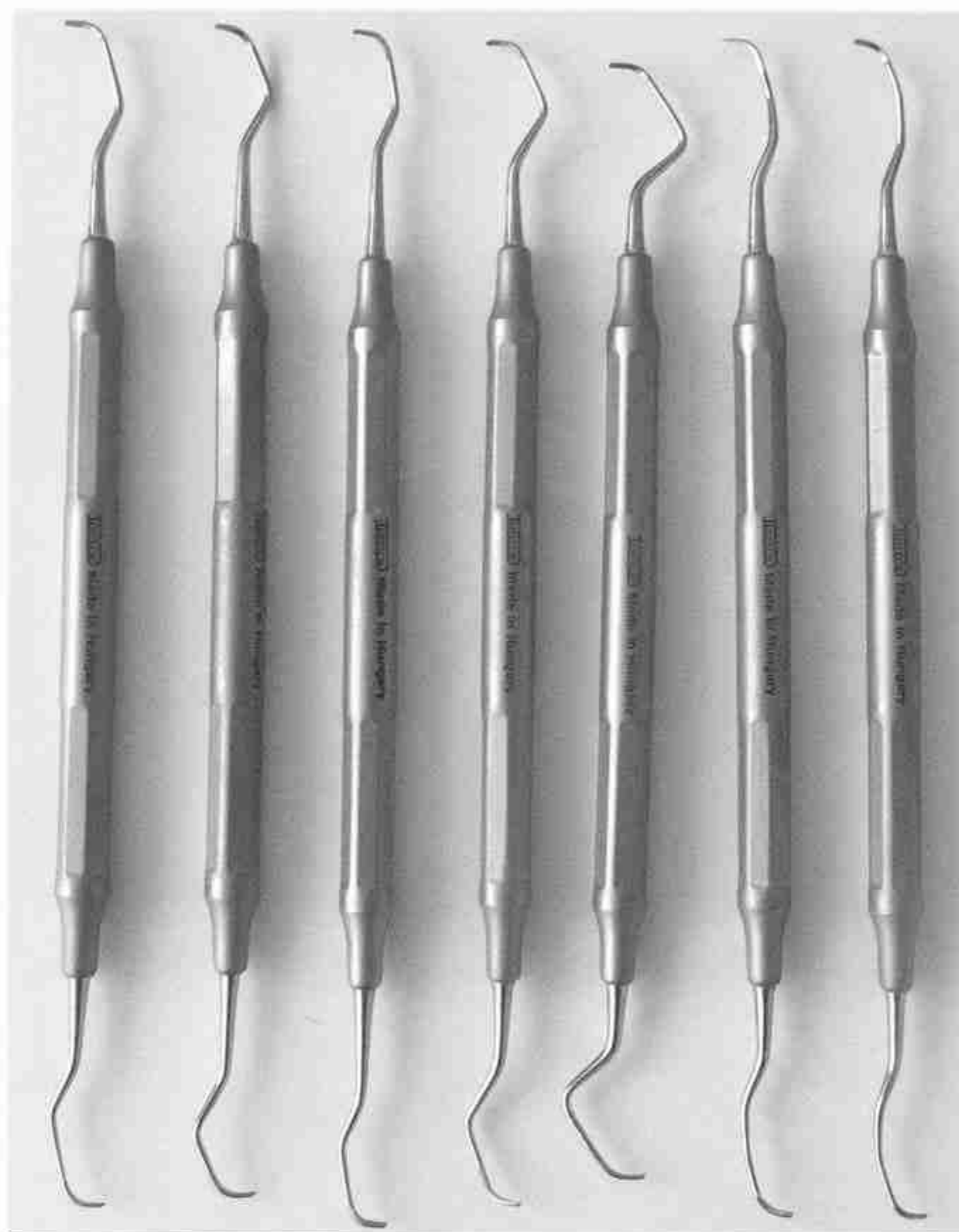
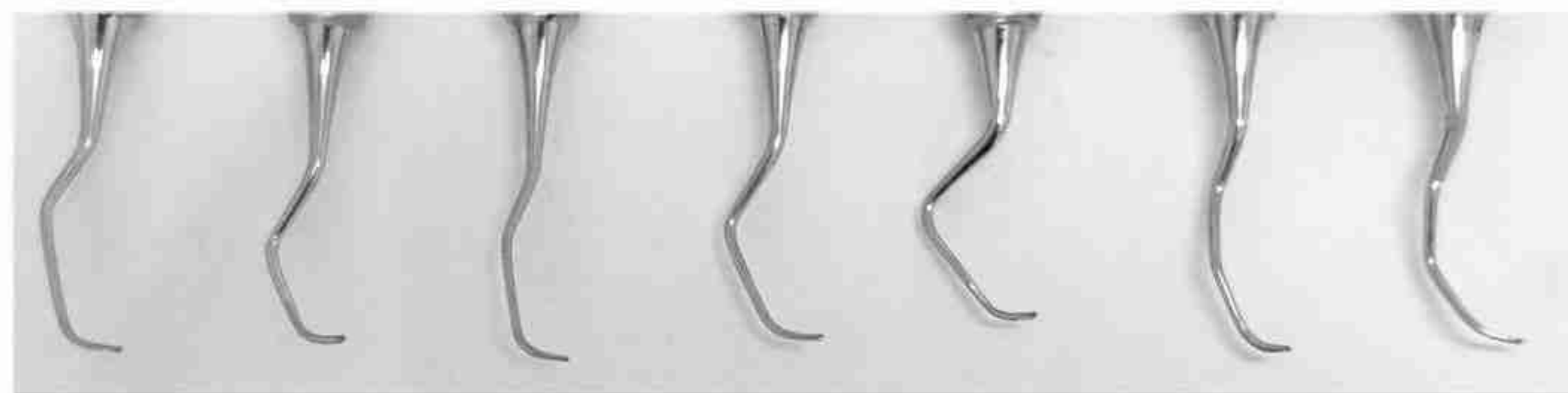

FOGKÓKAPARÓK - ZAHNREINIGER - SCALERS

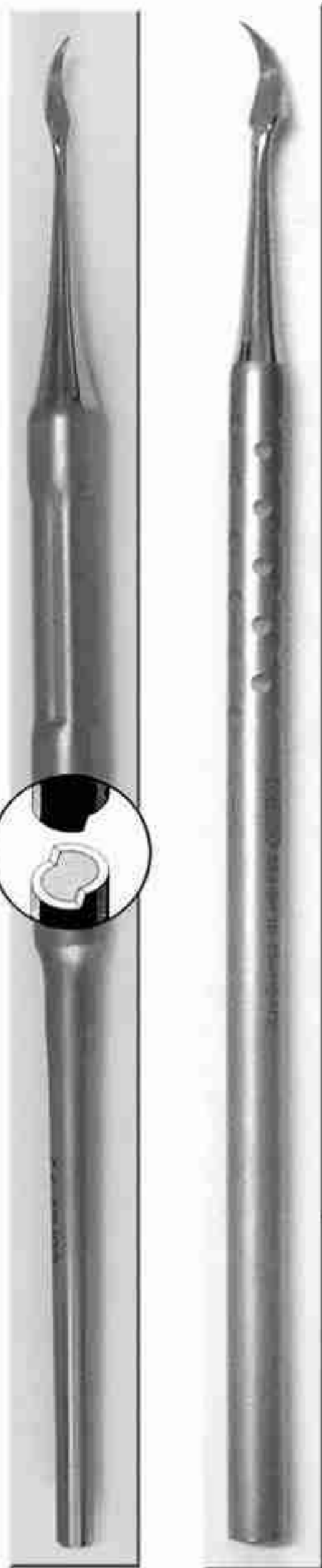

.../HG

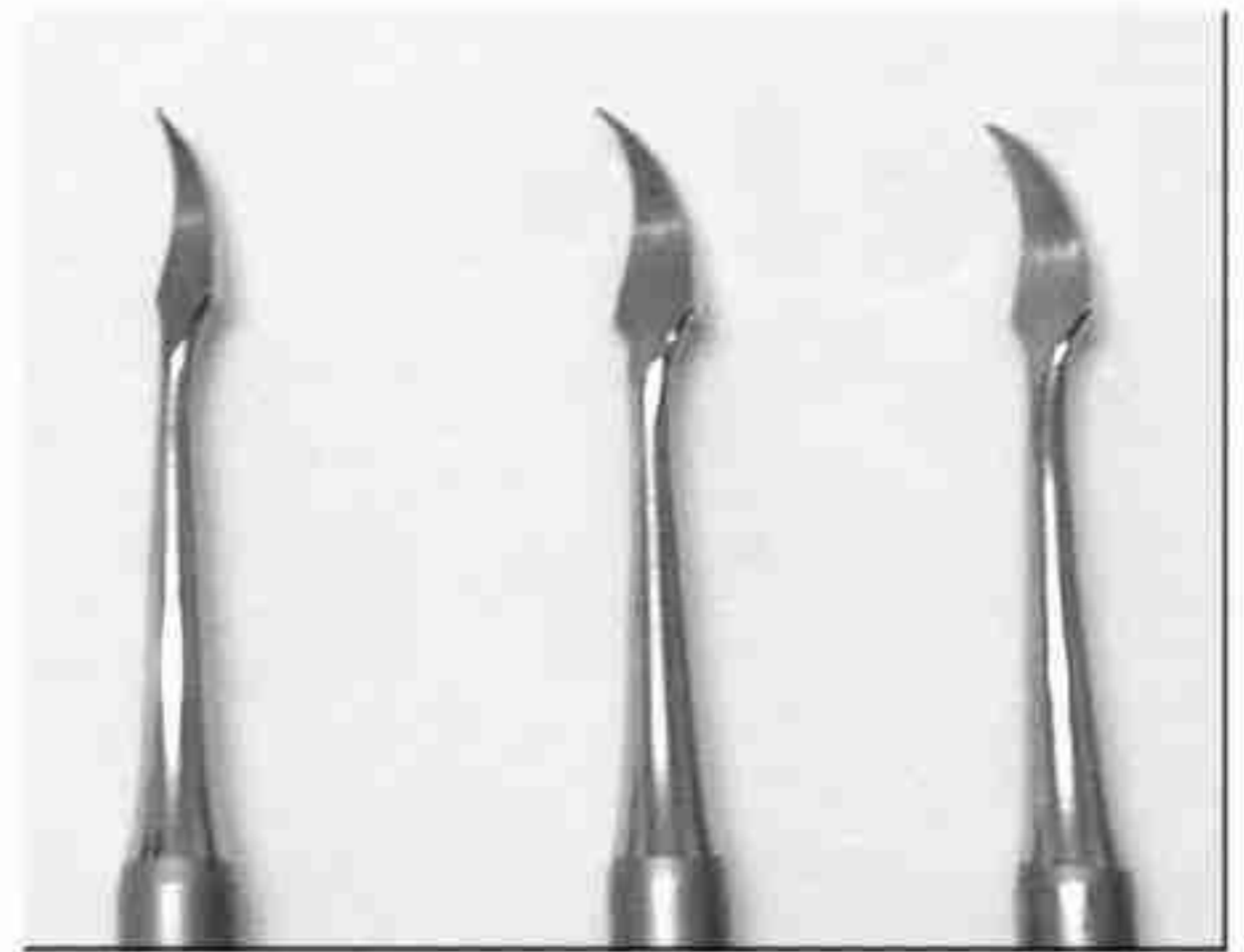

DB 1329

DB 1328

DB 1327



DB 1252

DB 1257

DB 1317

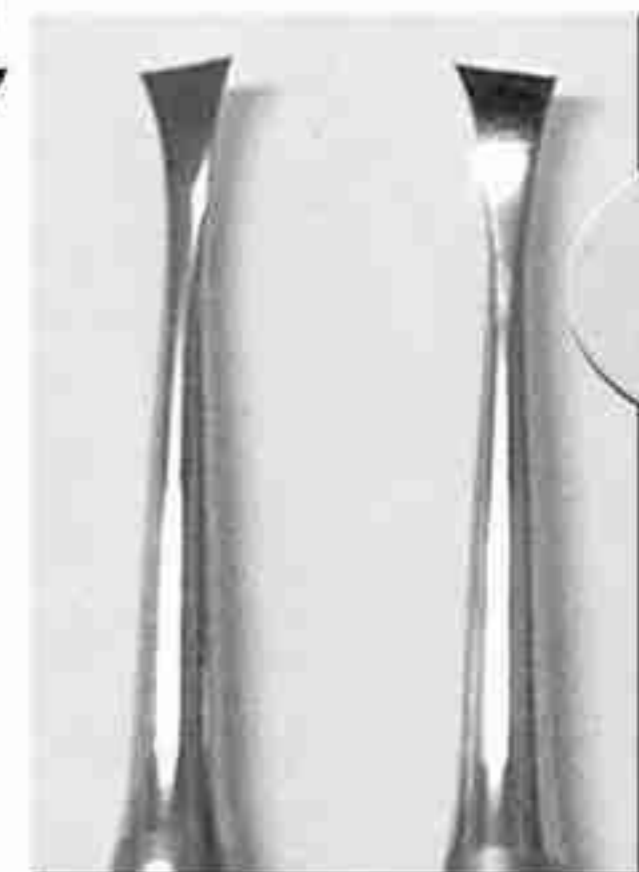

DB 1105

DB 1106

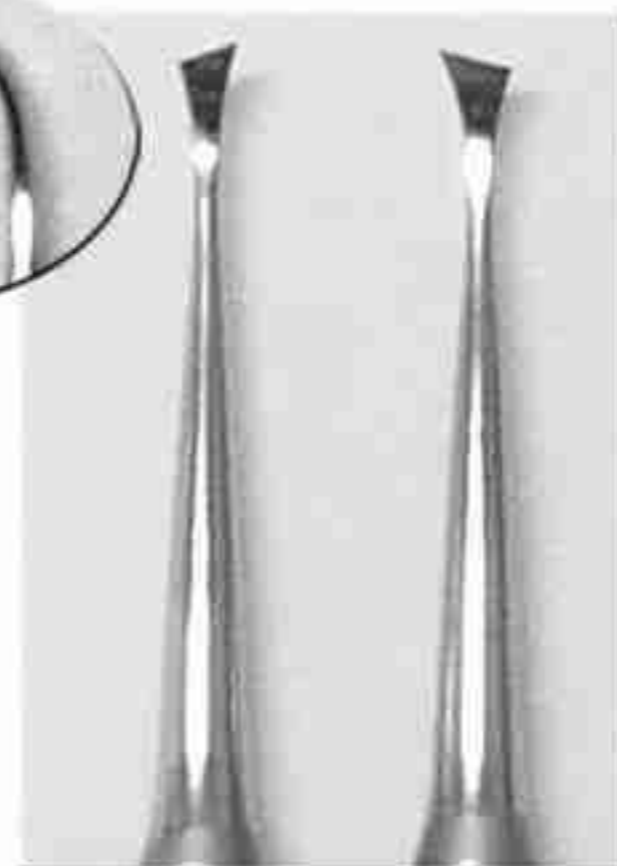
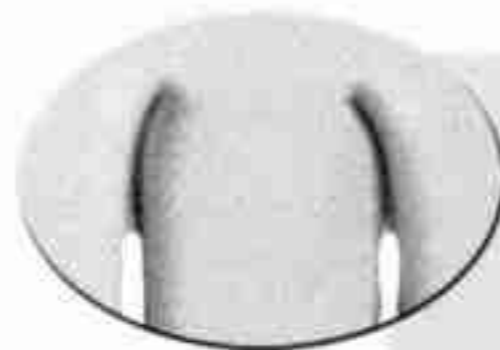

DB 1103

DB 1104



DB 1101

DB 1102

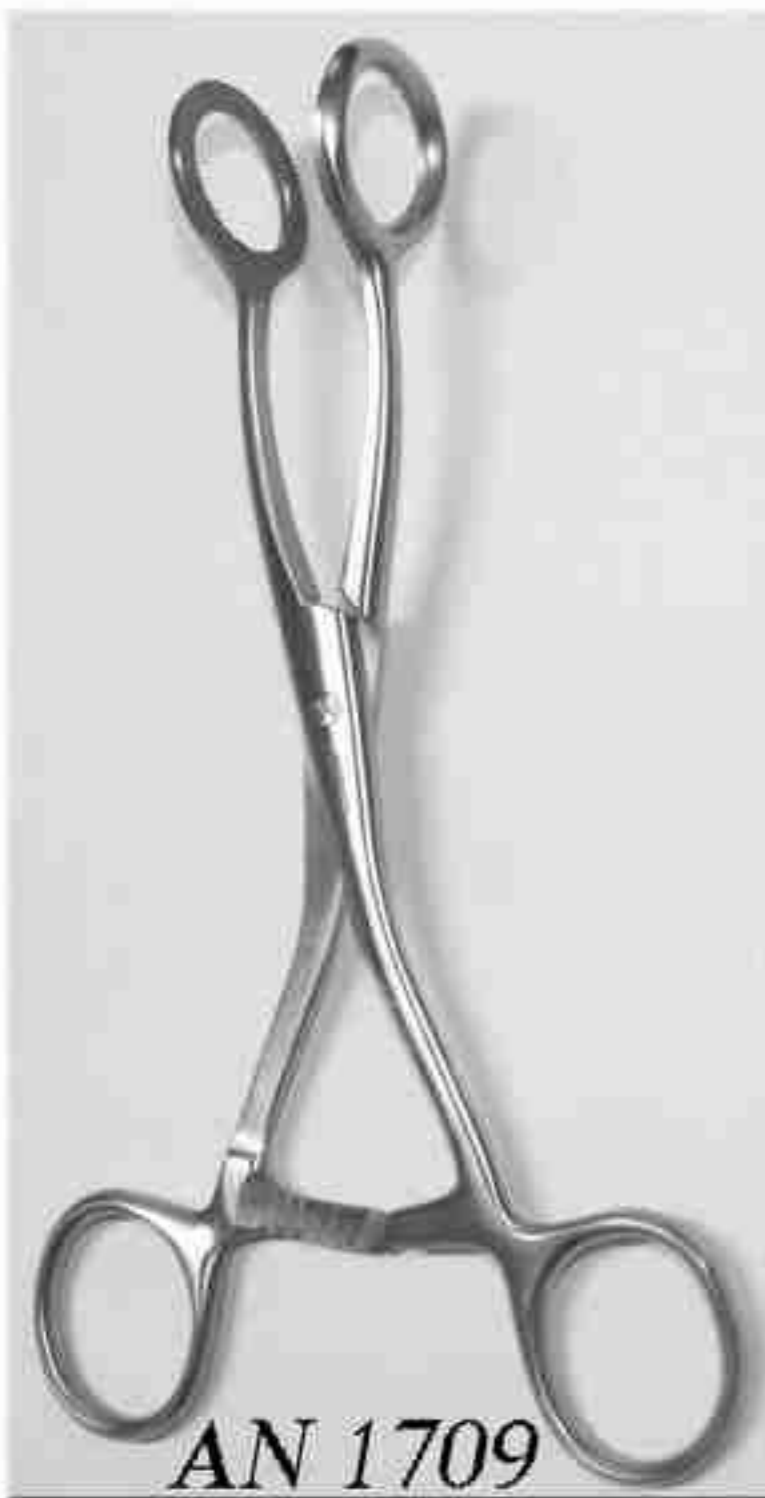

AN 1709

NYELVFOGÓ
 ZUNGEN ZANGE
 TONGUE HOLDING FORCEPS
 15 cm

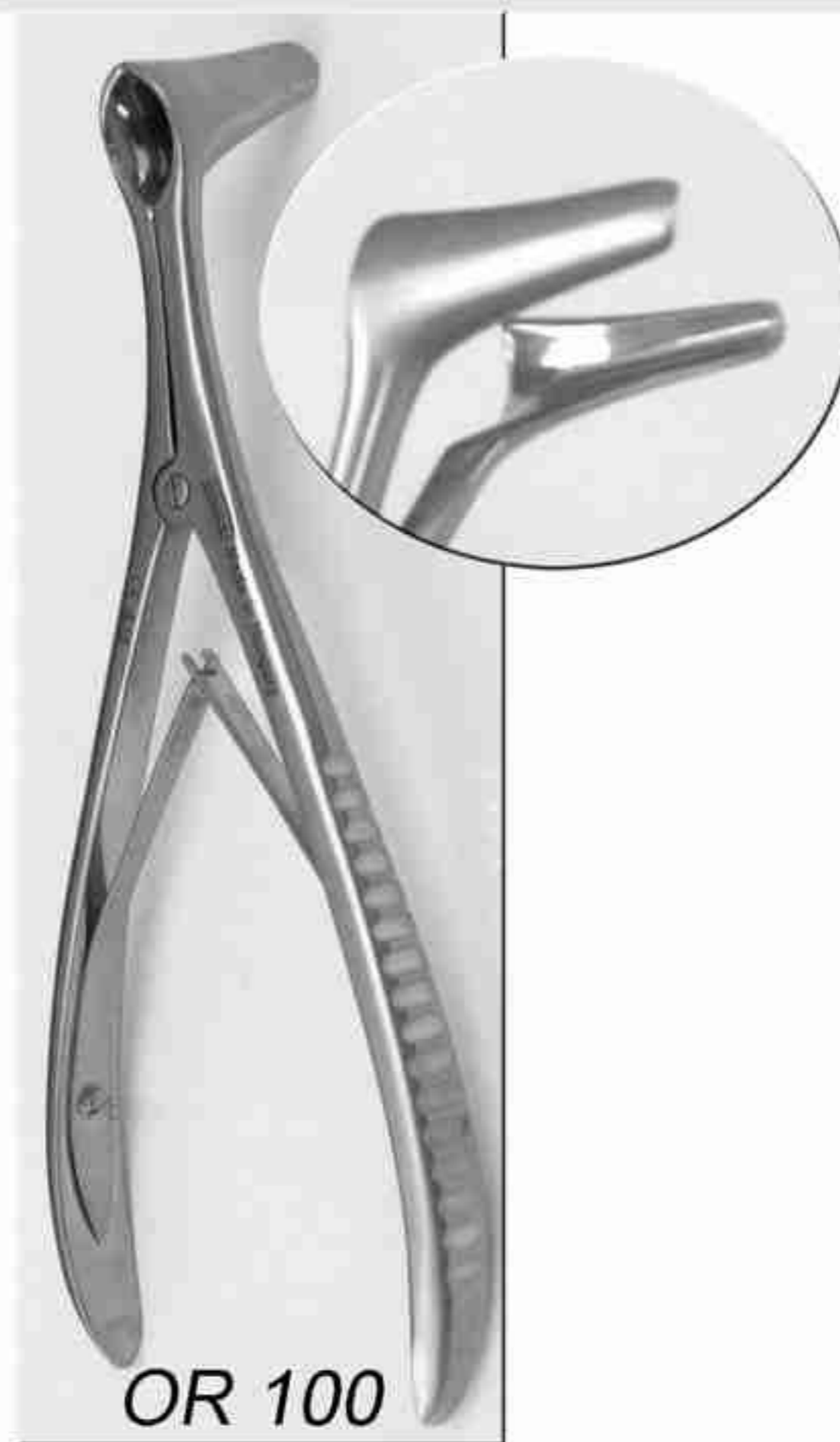

OR 100

ORRTERPESZTŐ HART-MANN
 HART-MANN NASENSPEKULA
 HART-MANN NASAL SPECULA
 17 cm



OM 149
 Roser - König
 16 cm

SZÁJTERPESZTŐK
 MUNDSPERRER
 MOUTH GAGS



OM 130
 Heister
 13 cm

FOGGYÖKÉREMELŐK -

ZAHNWURZELHEBER -

ROOT ELEVATORS

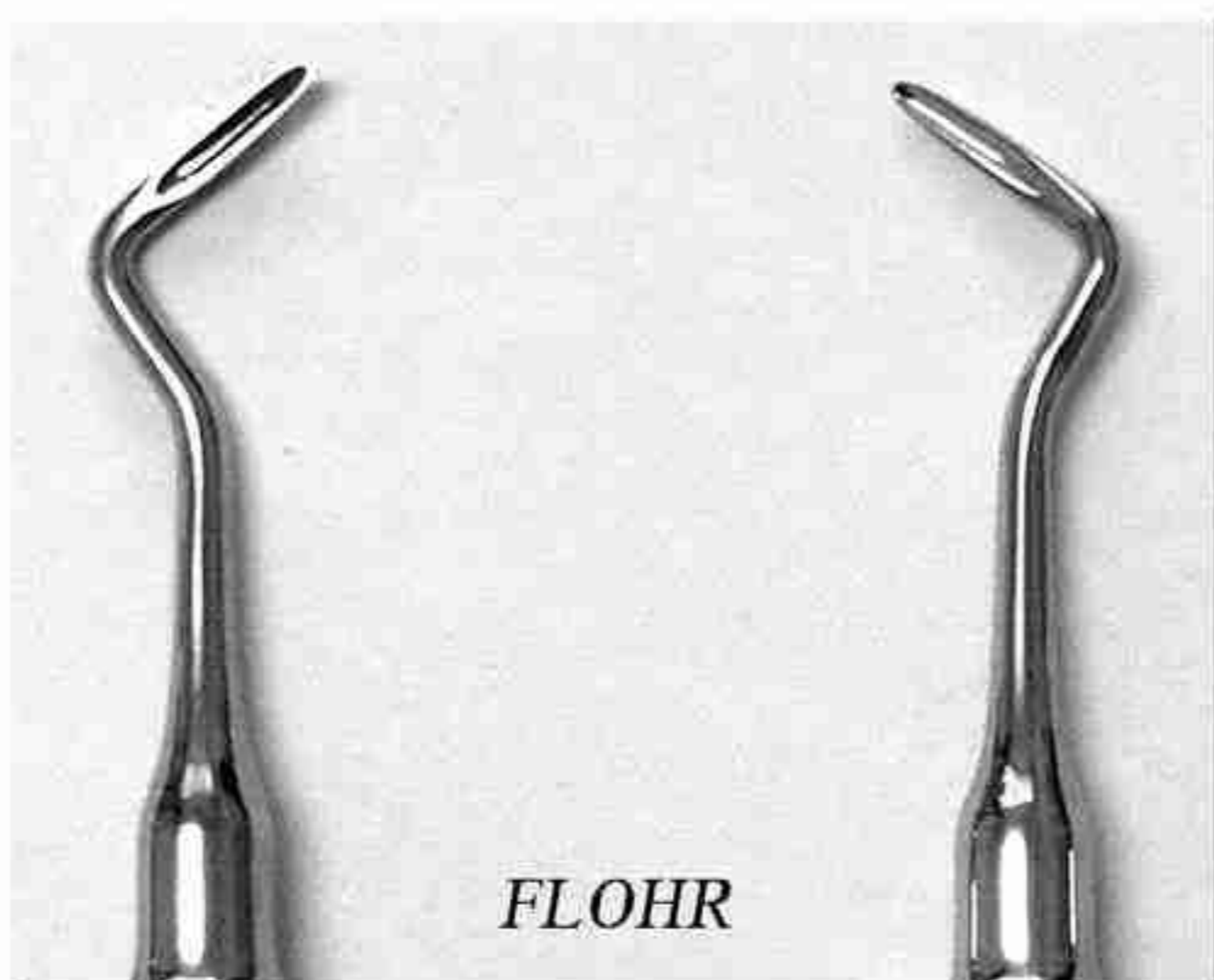
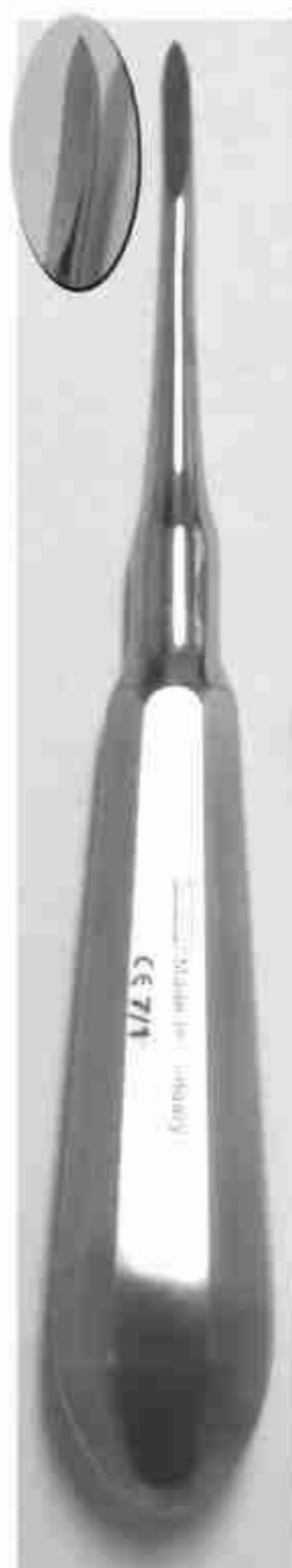

DL 1240
4 mm

DL 1241

DL 1234
4 mm

DL 1235

FOGGYÖKÉREMELŐK -

ZAHNWURZELHEBER -

ROOT ELEVATORS



DL 132
2 mm
FLOHR



DL 133
3 mm
FLOHR



DL 134
4 mm
FLOHR



DL 135
2 mm
BEIN



DL 136
3 mm
BEIN



DL 137
4 mm
BEIN



DL 138
3 mm
BEIN

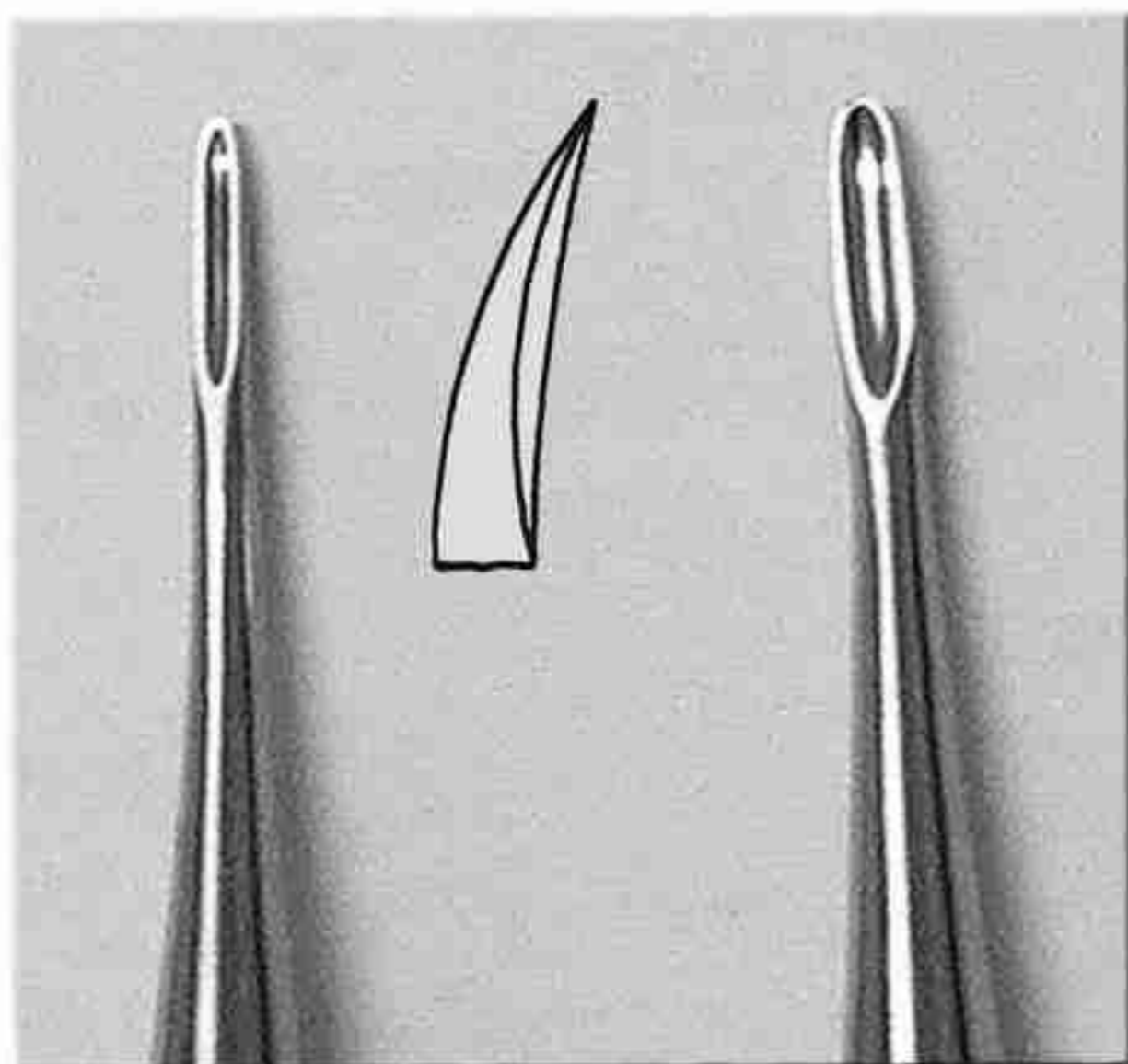

DL 162
3 mm
WHITE

DL 163
4 mm
WHITE

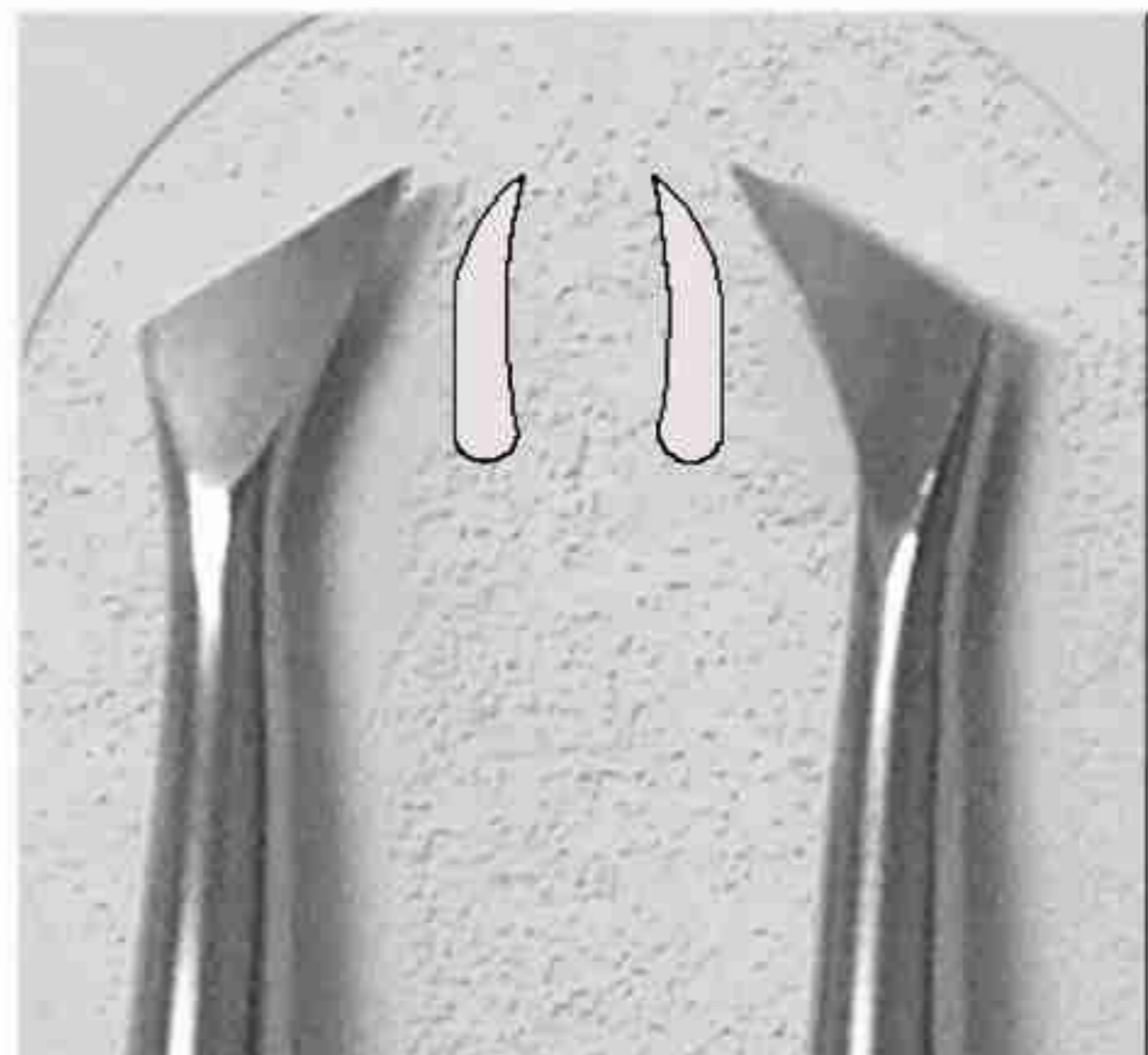

DL 1229

WINTER

DL 1230

FOGGYÖKÉREMELŐK -

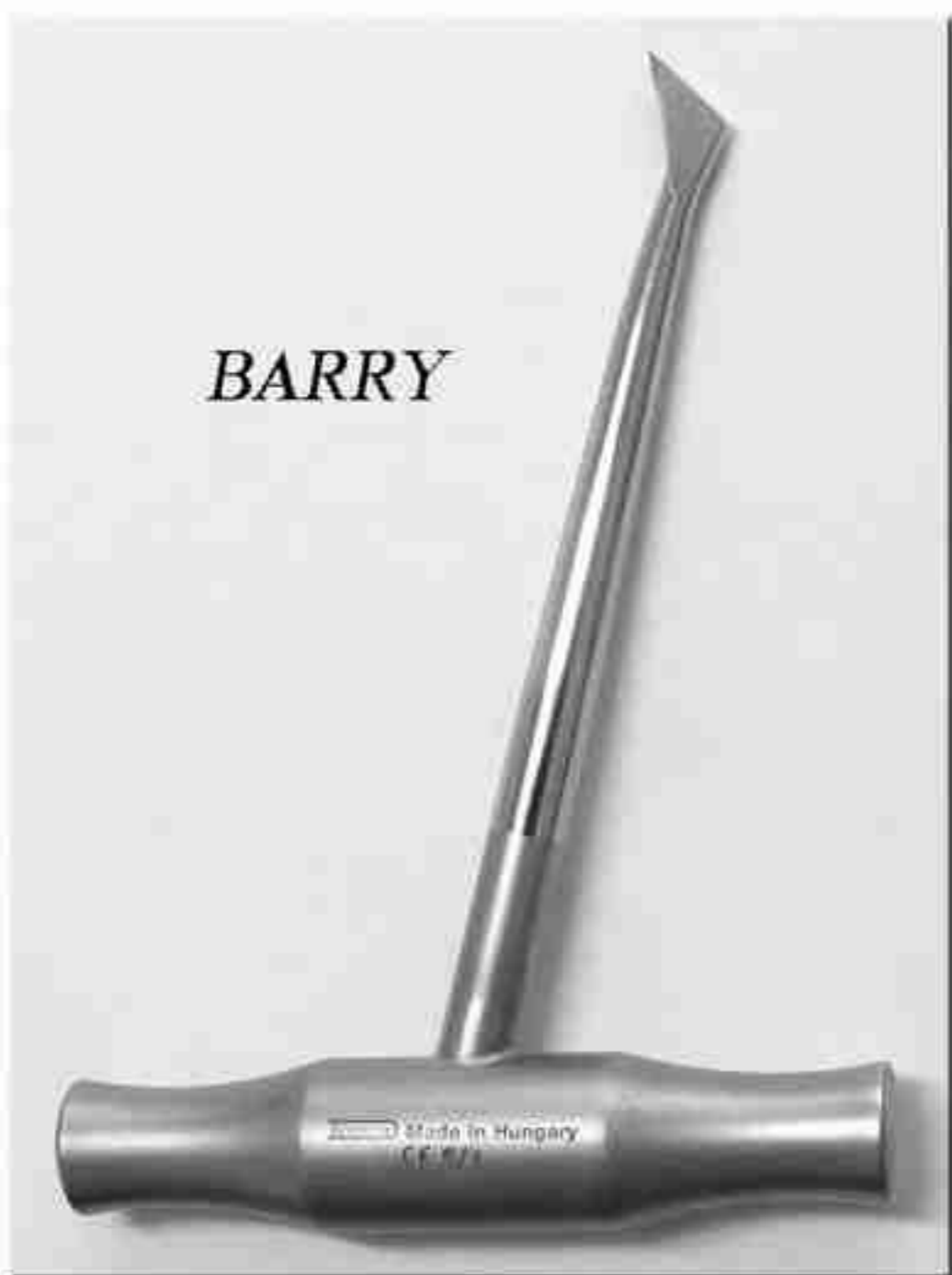

BARRY

ZAHNWURZELHEBER -

ROOT ELEVATORS

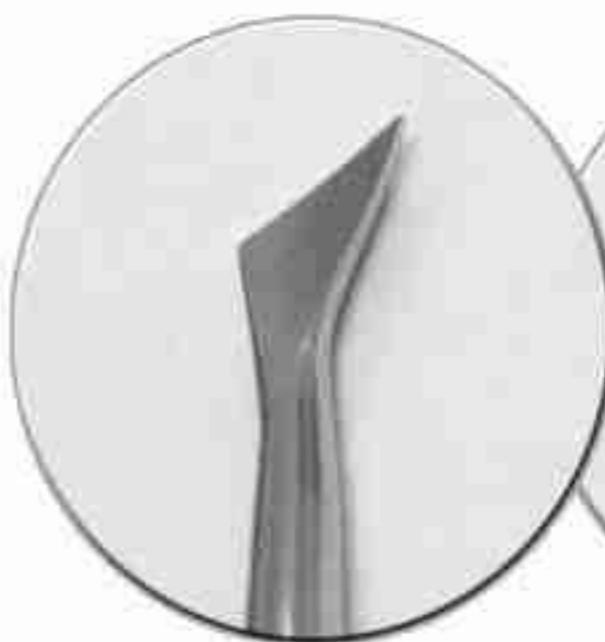

DL 1421

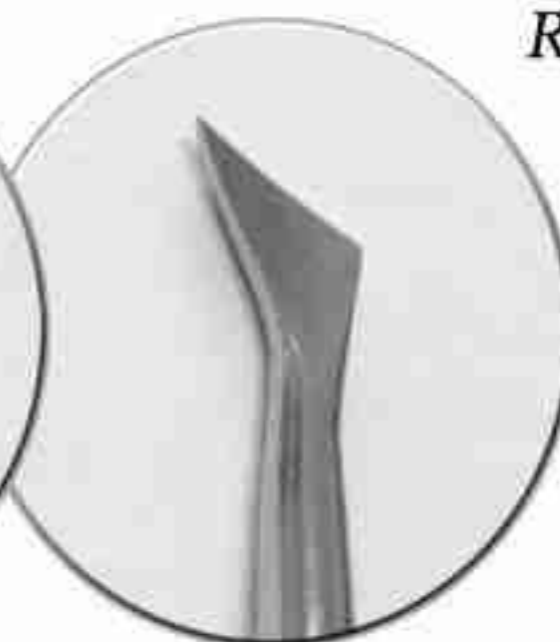

DL 1422



WINTER



DL 1427 3.5 mm

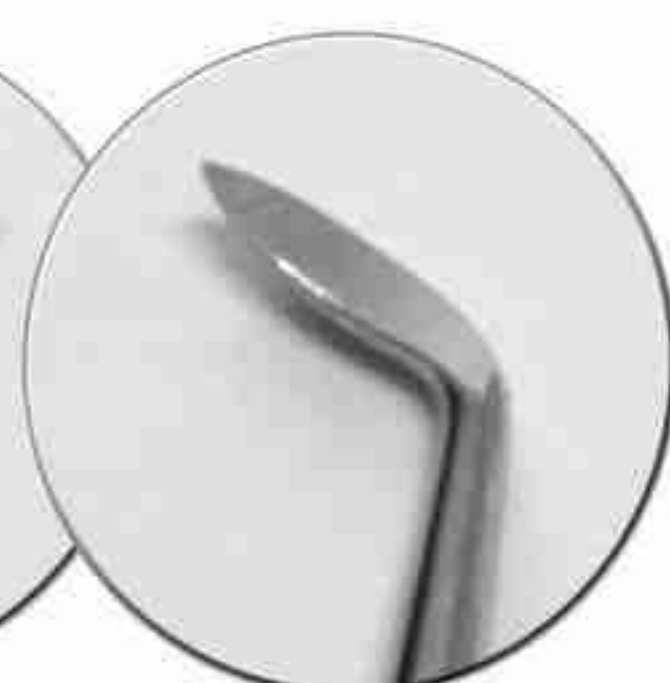

DL 1428



DL 1409

3 mm

DL 1410

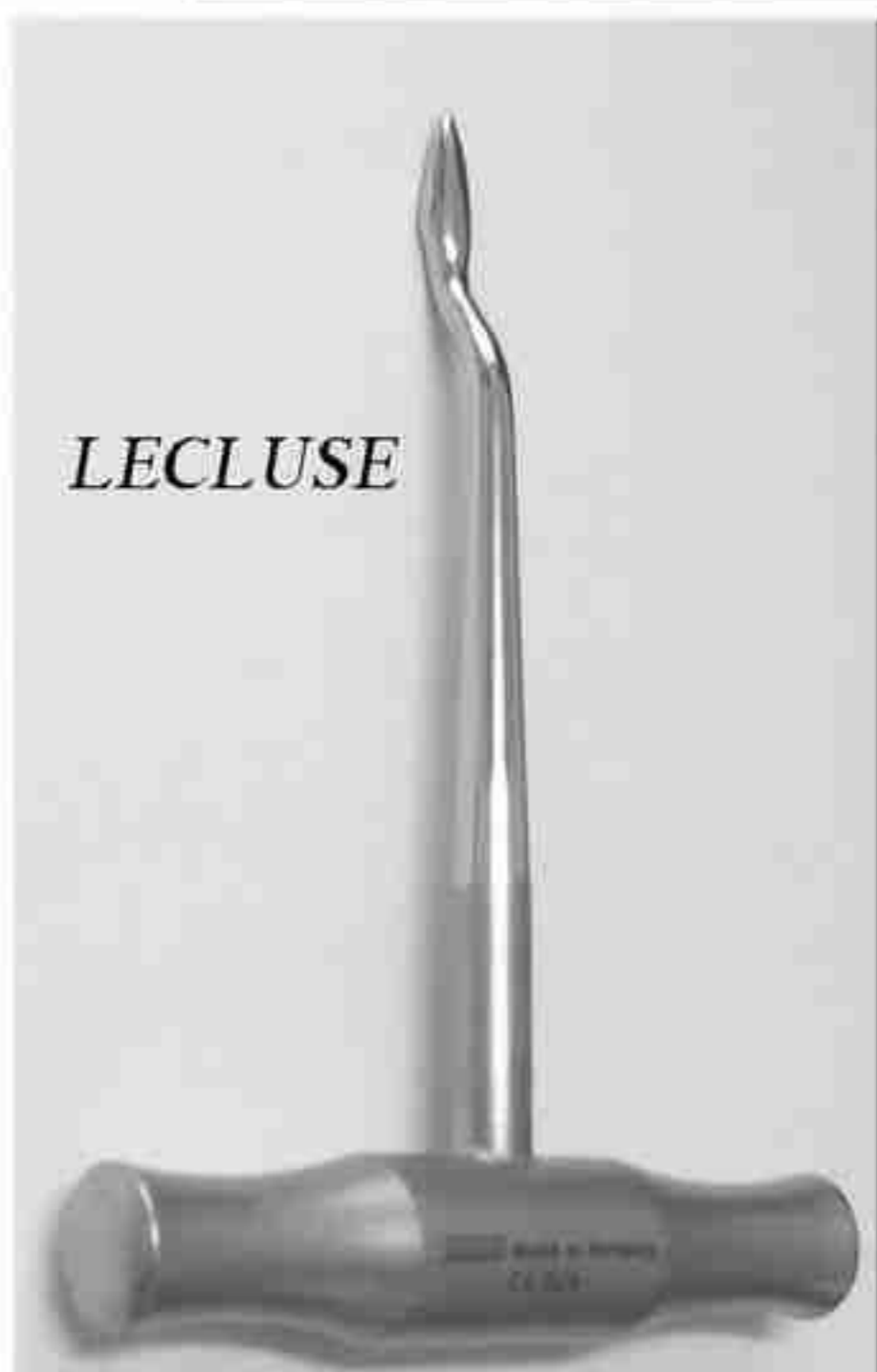

LECLUSE

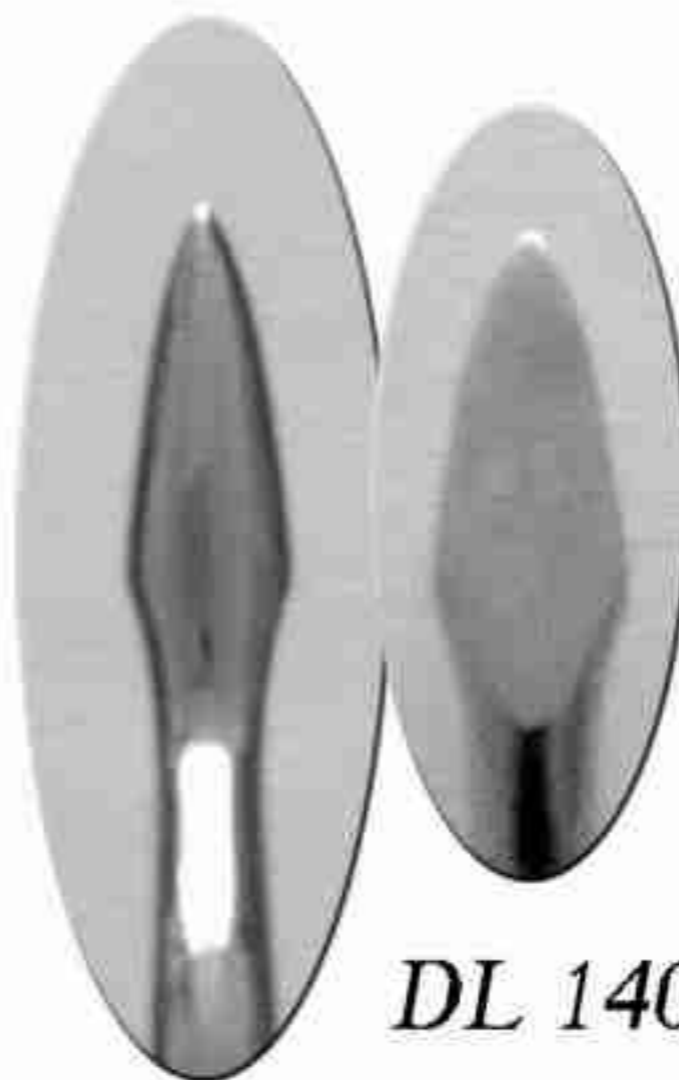

DL 1400

ÍRISZOLLÓK - IRISSCHEREN - IRIS SCISSORS



BC 156

10.5 cm

BC 1106

11.5 cm



BC 157

10.5 cm

BC 1107

11.5 cm



BC 1851 14.5 cm

BC 1852 18 cm

BC 1853 20 cm

KÖTSZEROLLÓ
VERBANDSCHERE
BANDAGE SCISSORS

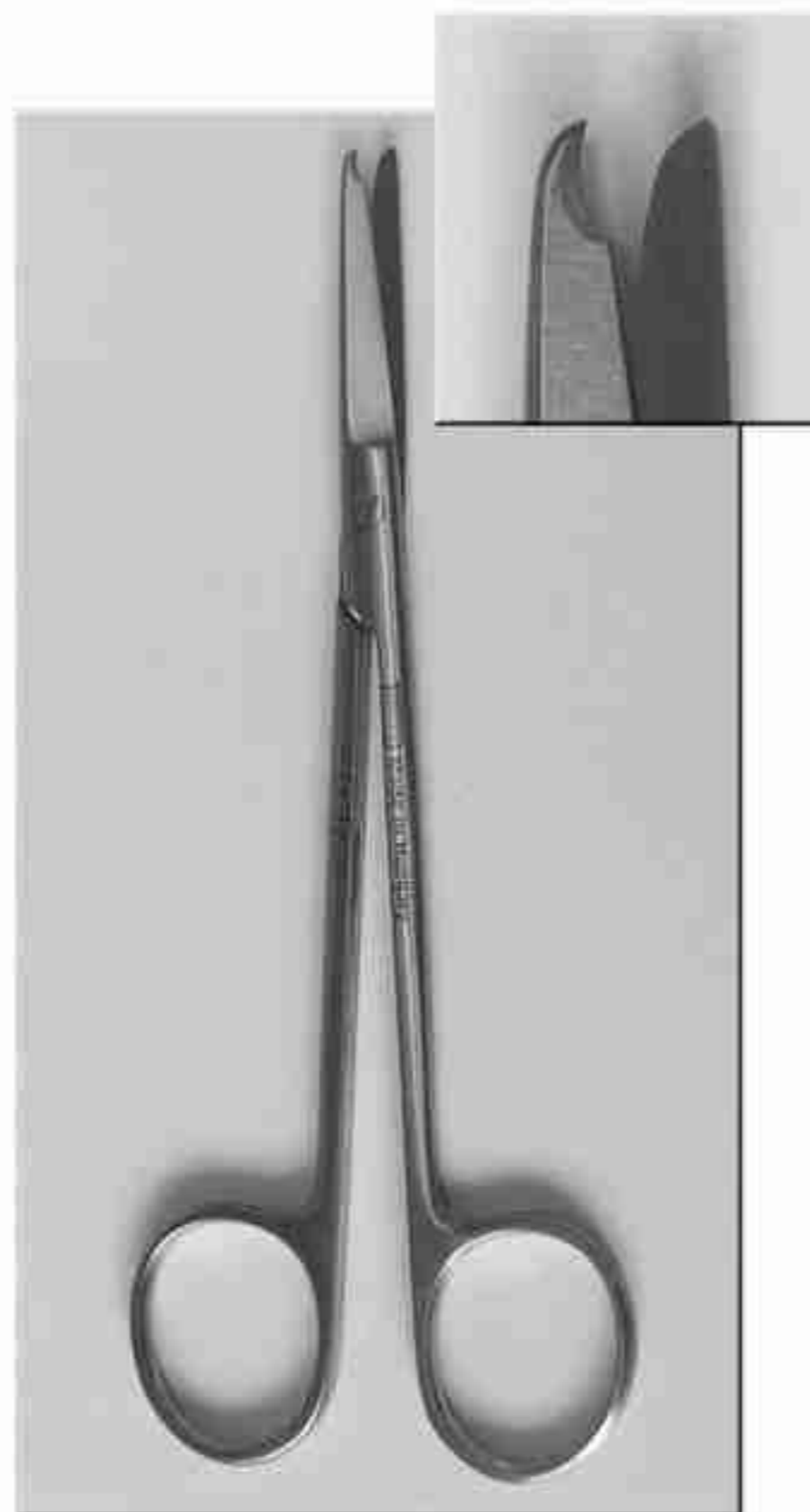

BC 1802 11 cm

BC 1803 14.5 cm

SPENCER
VARRATSZEDŐ OLLÓ
LIGATUR SCHERE
LIGATURE SCISSORS



DO 1211

DO 1210

FOGHÚS OLLÓ
ZAHNFLEISCHSCHERE
GUM SCISSORS
12 cm

SEBÉSZETI OLLÓK 14.5 cm -

CHIRURGISCHE SCHEREN 14.5 cm -

SURGICAL SCISSORS 14.5 cm

EGYENES - GERADE - STRAIGHT



BC 1314



BC 1324



BC 1344

HAJLÍTOTT - GEBOGEN - CURVED



BC 1414



BC 1424



BC 1444

SZÁJSEBÉSZETI OLLÓK
 SCHERE FÜR STOMATOLOGIE
 SCISSORS FOR STOMATOLOGY



BC 1000
 11 cm



BC 1001

GOLDMANN-FOX
 13 cm

LA GRANGE
 S hajlásu
 S förmig
 S shaped

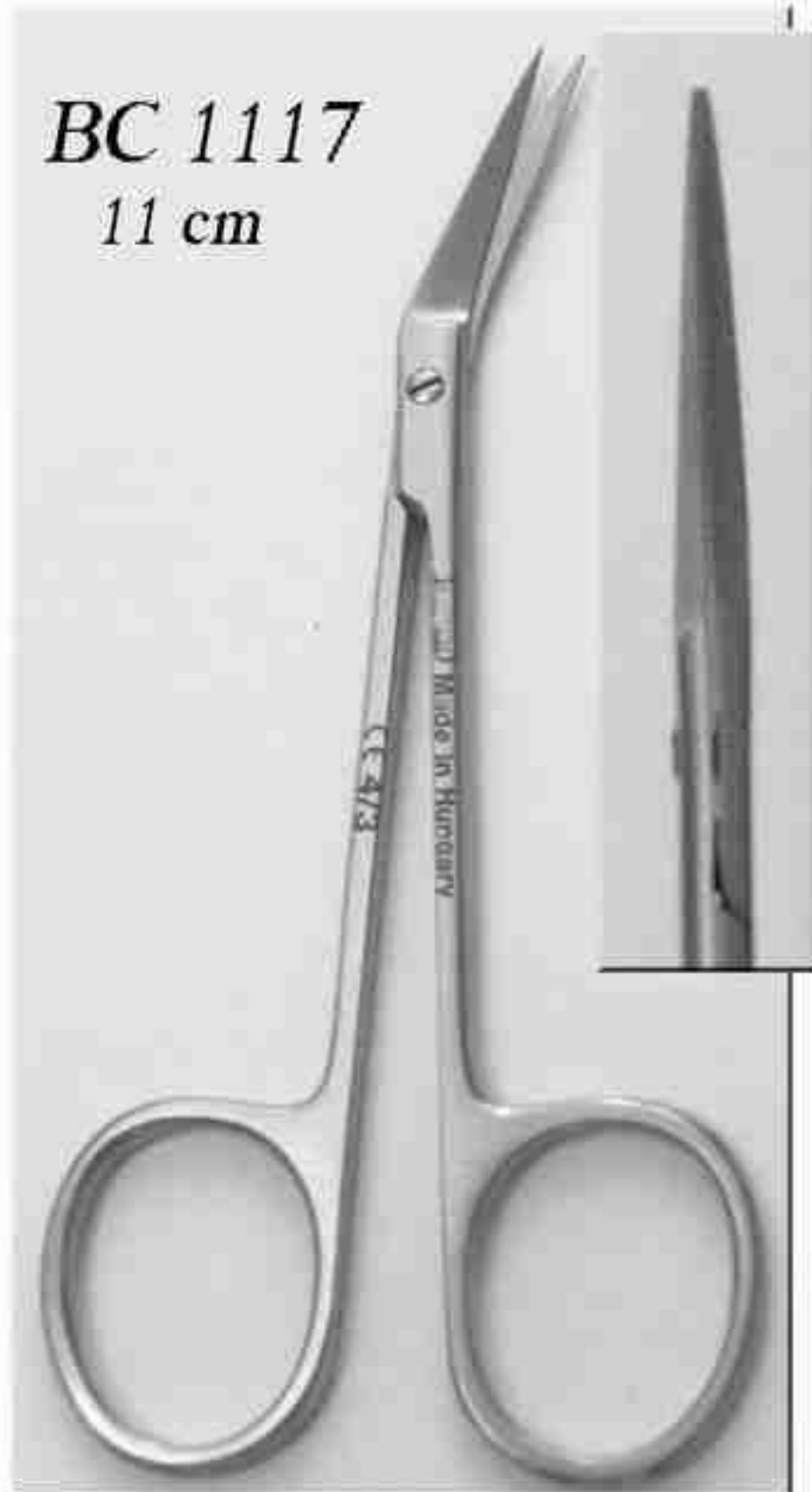

BC 1117
 11 cm

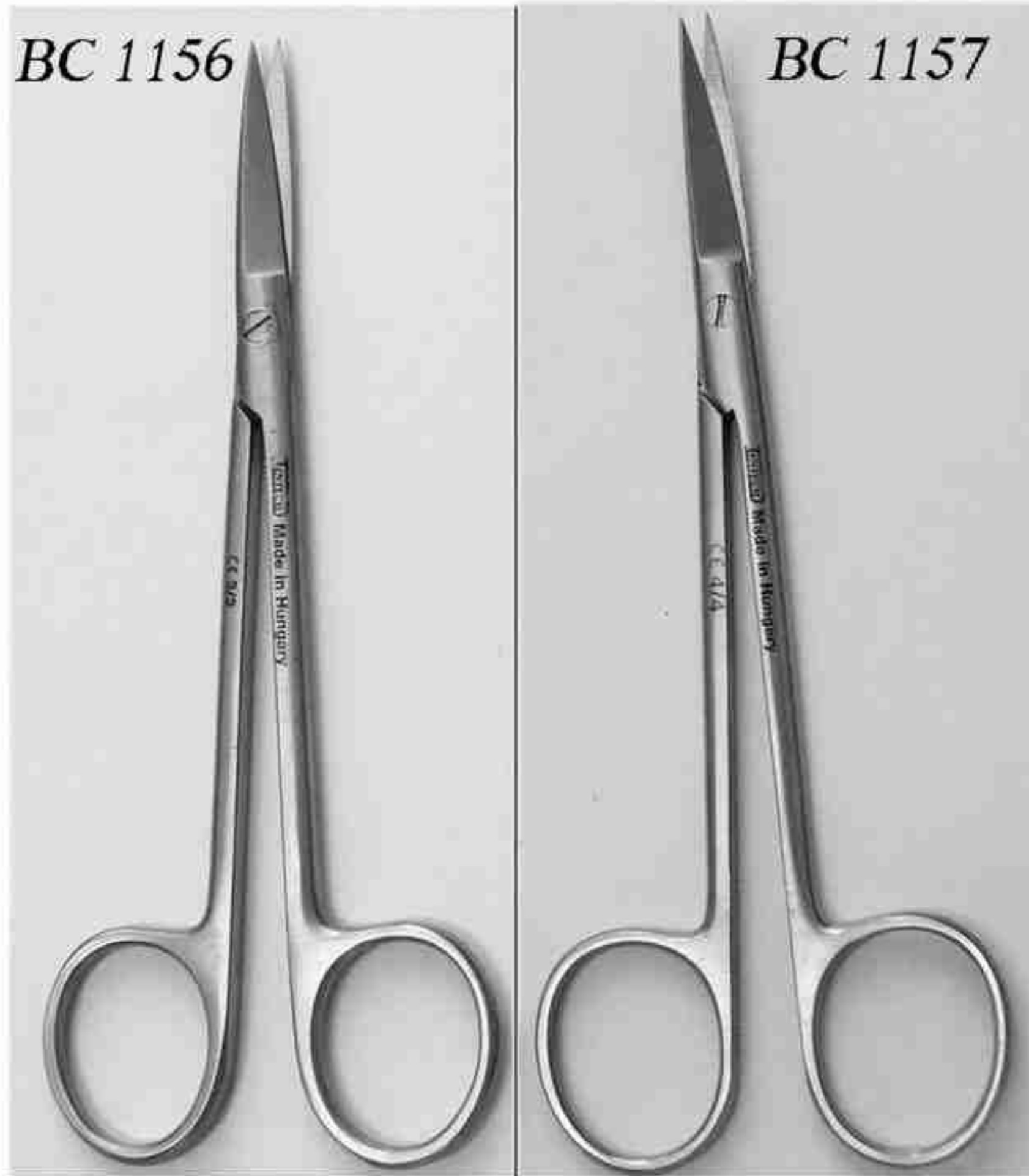

BC 1156

BC 1157

JOSEPH
 14 cm

VARRATSZEDŐ OLLÓ
 LIGATUR SCHERE
 LIGATURE SCISSORS



BC 1118
 egyenes
 gerade
 straight

METZENBAUM-FINO OLLÓ
METZENBAUM-FINO-SCHERE
METZENBAUM-FINO SCISSOR
 18 CM



BC 1119
 hajlított
 gebogen
 curved

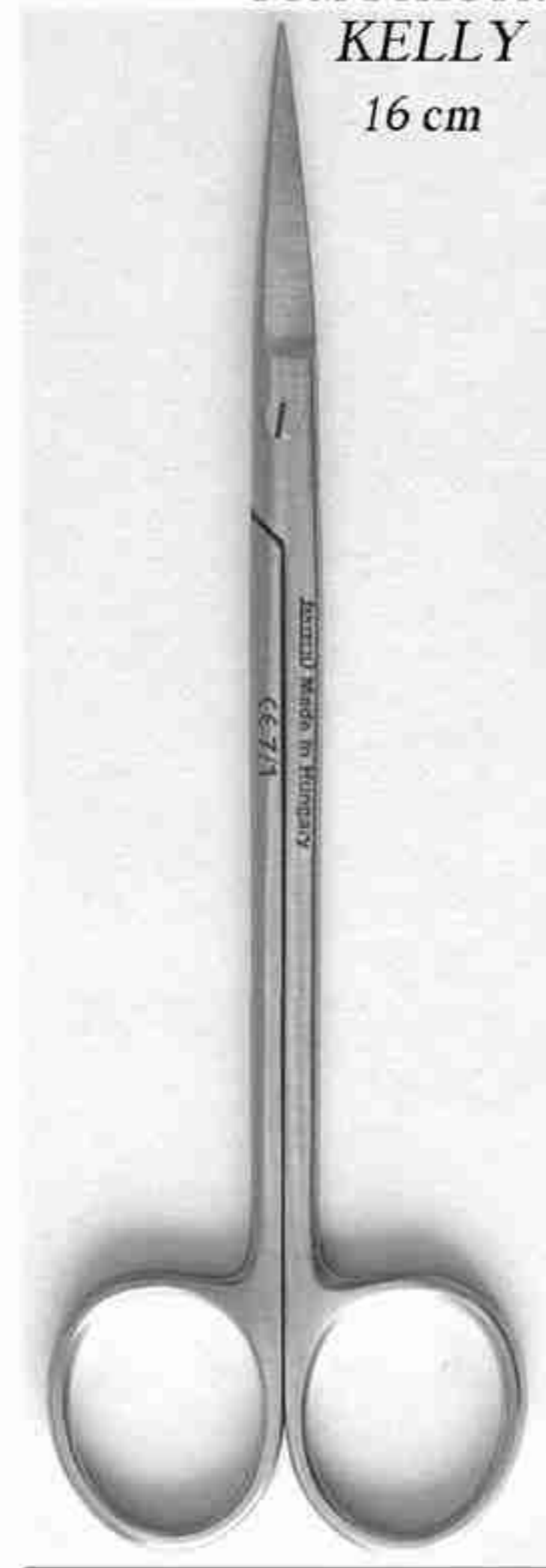

FOGHÚSOLLÓ
ZAHNFLEISSCHEREN
GUM SCISSORS
KELLY
 16 cm



BC 1175
 hajlított
 gebogen
 curved



BC 1114
 egyenes
 gerade
 straight



BC 1115
 hajlított
 gebogen
 curved

METZENBAUM-FINO OLLÓ
METZENBAUM-FINO-SCHERE
METZENBAUM-FINO SCISSOR
 14,5 CM

BC 1174
 egyenes
 gerade
 straight



BC 1176
 S hajlásu
 S förmig
 S shaped



BT 1400
18.5 cm

SEBKAMPÓ BALOGH-FÉLE
WUNDHAKEN NACH BALOG
RETRACTORS BALOGH



SEBKAMPÓ
WUNDHAKEN
RETRACTORS
BT 1401 19.5 cm

SZÁJZUGKAMPÓK - MUNDHAKEN - RETRACTORS



OM 1205
 NYELVLAPOC
 ZUNGENSPELTEL
 TONGUE SPATULAS
 16 cm



BT 1404	BT 1405	BT 1406
15 x 15 mm 20 cm	20 x 22 mm 21 cm	26 x 30 mm 23 cm

SZÁJSEBÉSZETI KAMPÓ, TOMPA
 WUNDHAKEN, STUMPF
 RETRACTOR, BLUNT



WILLIGER DO 1404

DO 1405

DO 1406



MIDDELDORPF

HEGYES
 SHARP
 SHARP

BT 1111

BT 1112

BT 1113

BT 1114



SEBKAMPÓK
 WUNDHAKEN
 RETRACTORS

16 cm



TOMPA
 STUMPF
 BLUNT

BT 1116

BT 1117

BT 1118

BT 1119



SEBKAMPÓK - WUNDHAKEN - RETRACTORS

KOCHER - LANGENBECK

21.5 cm



BT 1354 25 x 6 mm



BT 1356 35 x 8 mm



BT 1357 35 x 11 mm



BT 1358 35 x 15 mm



BT 1359 41 x 11 mm



BT 1361 55 x 11 mm

BT 1320 28 x 10 mm



BT 1321 28 x 14 mm



BT 1322 33 x 14 mm



BT 1323 28 x 16 mm



BT 1325 40 x 10 mm



BT 1326 40 x 13 mm



LANGENBECK

21 cm



SEBKAMPÓK - WUNDHAKEN - RETRACTORS



VOLKMANN

18.5 cm



- BT 1342 38 x 10 mm
- BT 1343 36 x 15 mm
- BT 1344 35 x 20 mm
- BT 1345 34 x 25 mm
- BT 1346 33 x 30 mm



CUSHING

22.5 cm



BT 1408 25 x 27 mm

VESTIBULUM KAMPÓ
 VESTIBULUM HAKEN - VESTIBULUM RETRACTOR

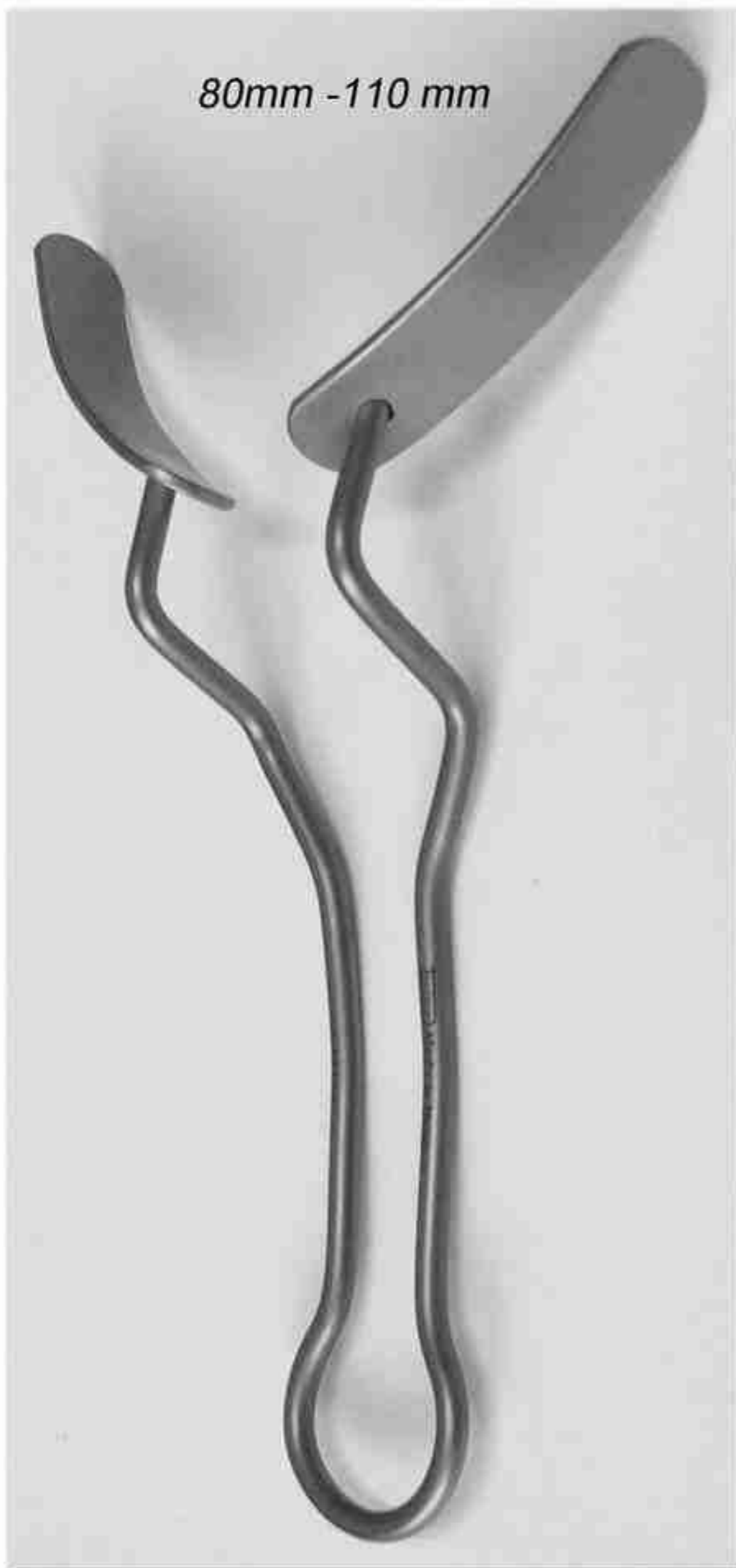

VT 100

*felső
 obere
 upper
 17 cm*

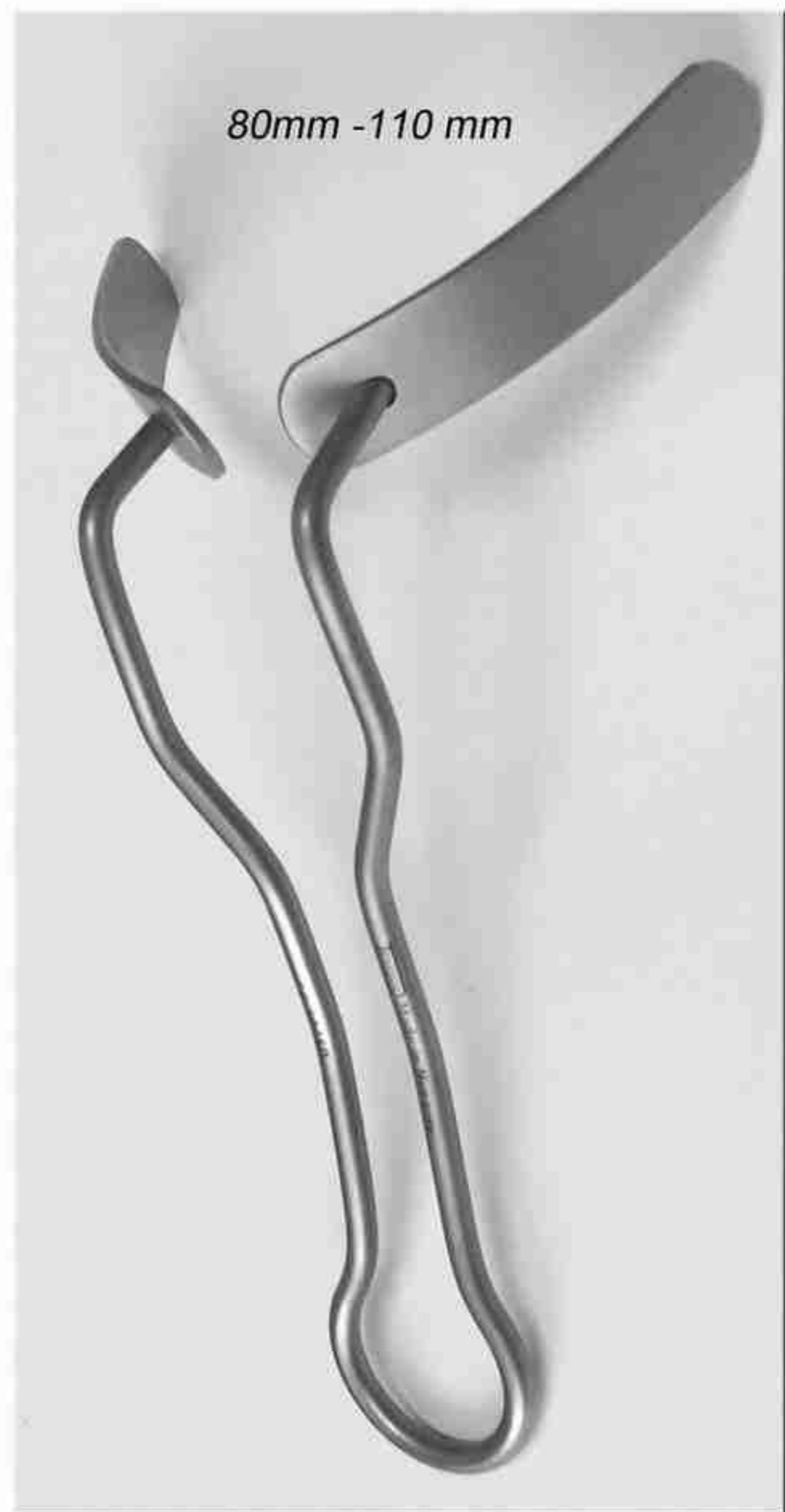

VT 101

*also
 untere
 lower
 17 cm*

ÉLESKANALAK - SCHARFE LÖFFEL - BONE CURETTES



VOLKMANN - FÉLE
17 cm

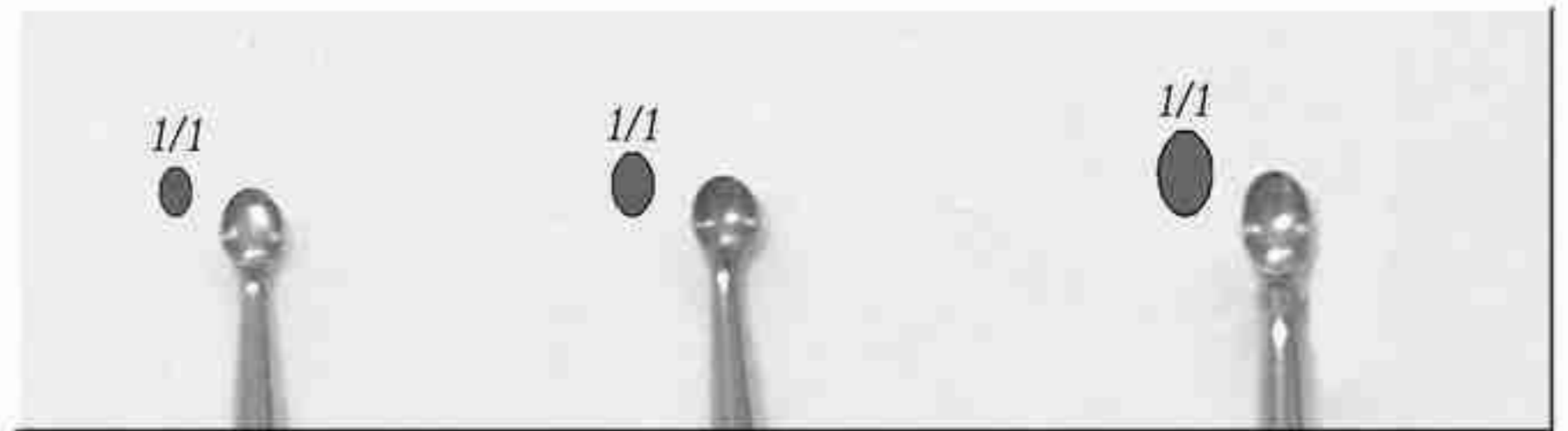

fig. 0000

FK 1630

2 x 3,5

fig. 000

FK 1631

3 x 4,6

fig. 00

FK 1632

4 x 6,2

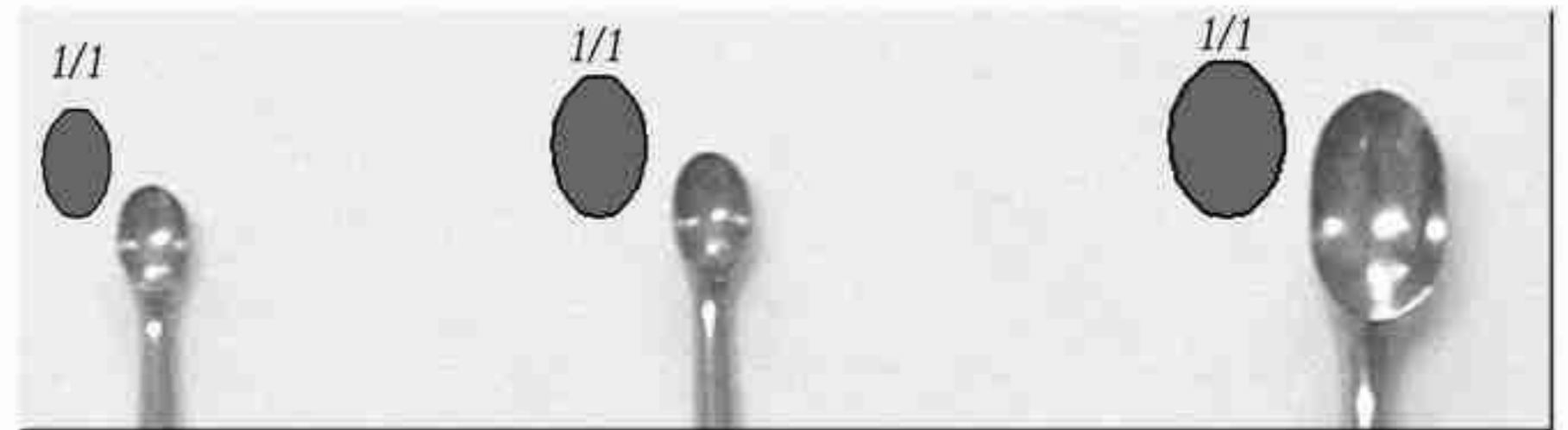

fig. 0

FK 1633

5 x 8

fig. 1

FK 1634

7 x 10,5

fig. 2

FK 1635

8,6 x 11,6



LUCAS KANÁL
LUCAS SCHARFE LÖFFEL
LUCAS BONE CURETTES



DO 1653



DO 1654



KERPEL - FÉLE



DO 1630

2 x 3,5



DO 1631

2 x 3,5



DO 1632

3 x 4,6



DO 1633

2,5 x 4

ÉLESKANALAK - SCHARFE LÖFFEL - BONE CURETTES

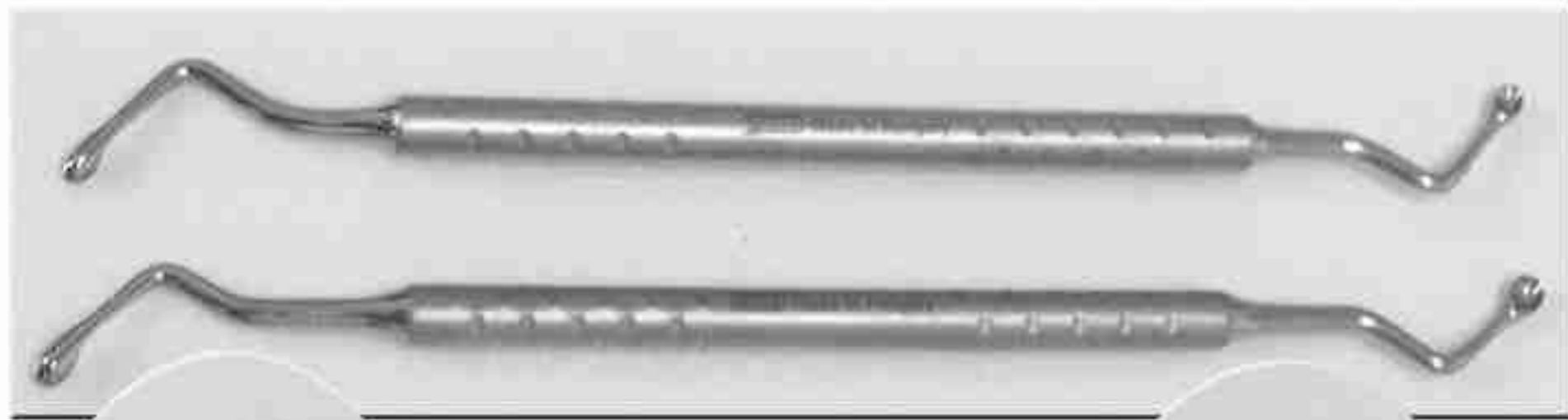

DO 1655
2 x 3,5

DO 1656
3 x 4,6

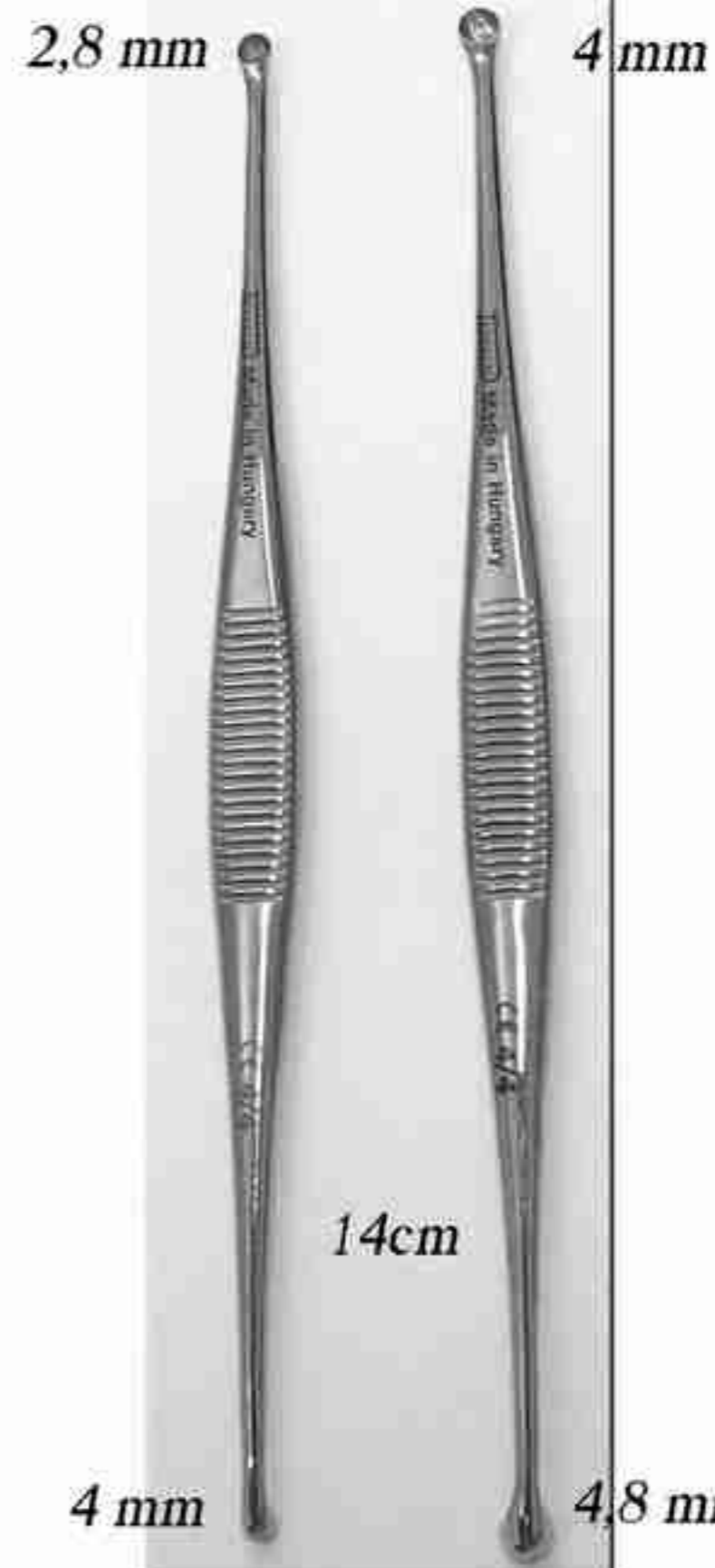

FK 1800 FK 1801

RASPATÓRIUM
RASPATORIES

6,5 mm



FK 1300
16 cm

6 mm



FK 1301
13 cm

Williger



Tompa/ éles
stumpf/ scharf
blunt/ sharp

FK 1164 2,5 mm
FK 1165 4 mm
FK 1166 6 mm

Freer



FK 1611
5 mm

FK 1612
4 mm

Partsch

TÚFOGÓK - NADELHALTER - NEEDLE HOLDERS



BM 1234	13 cm
BM 1235	16 cm
BM 1236	18 cm
BM 1237	20 cm

KEMÉNYFÉM BETÉTES
TC



BM 2234	13 cm	TC
BM 2235	16 cm	TC
BM 2236	18 cm	TC
BM 2237	20 cm	TC

BM 1360	14 cm
BM 1361	17 cm
BM 1362	20 cm

KEMÉNYFÉM BETÉTES
TC



BM 2360	14 cm	TC
BM 2361	17 cm	TC
BM 2362	20 cm	TC

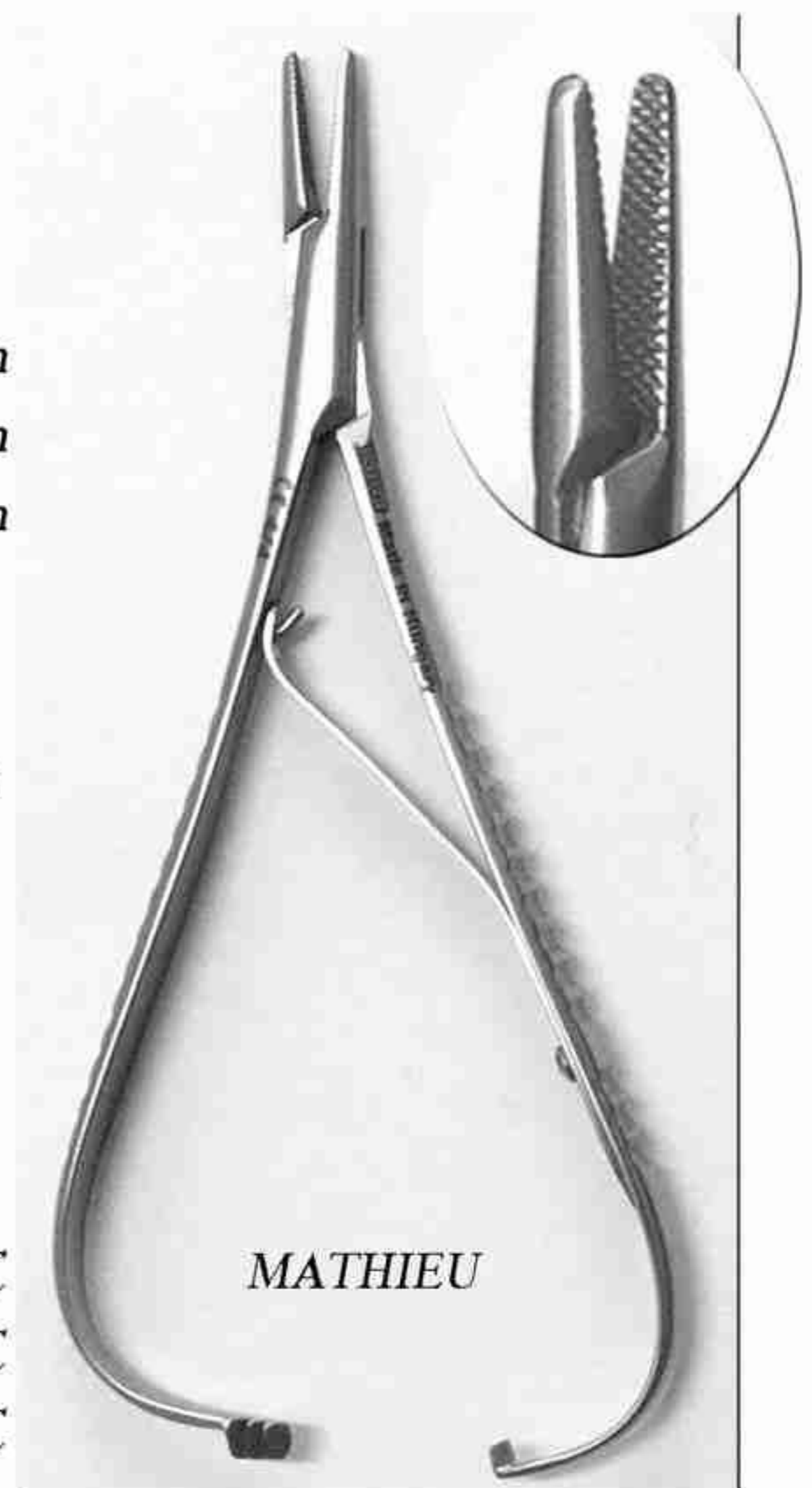

CEMENTSPATULA -

ZEMENTSPATELN -

CEMENT SPATULAS
DOUBLE-ENDED

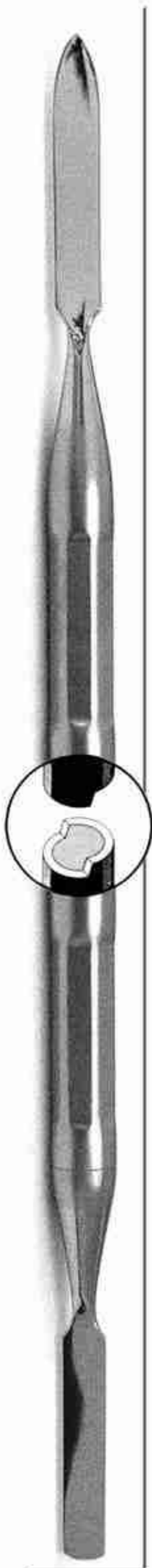

..../HG



DF 1150
4.5 mm

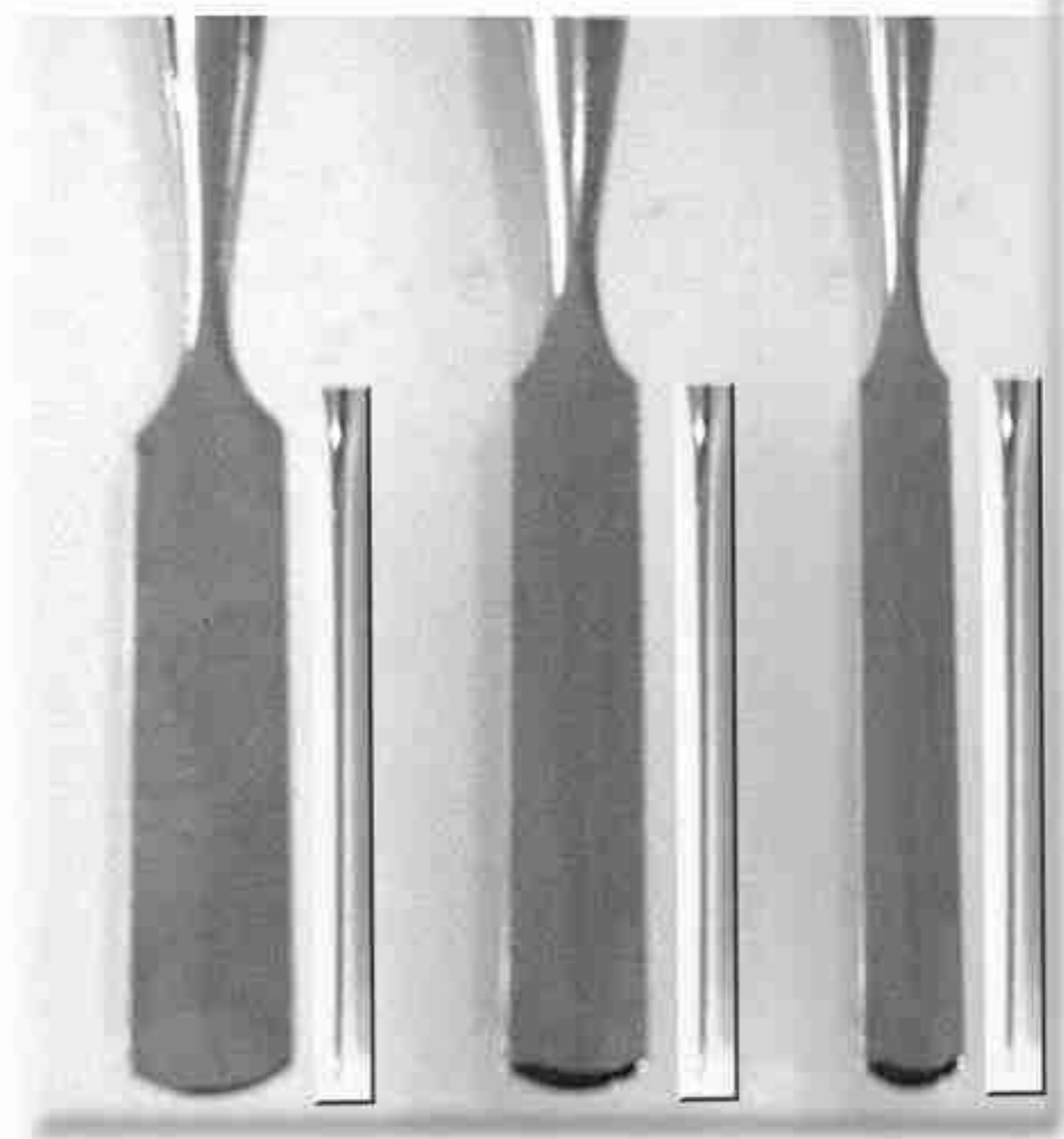
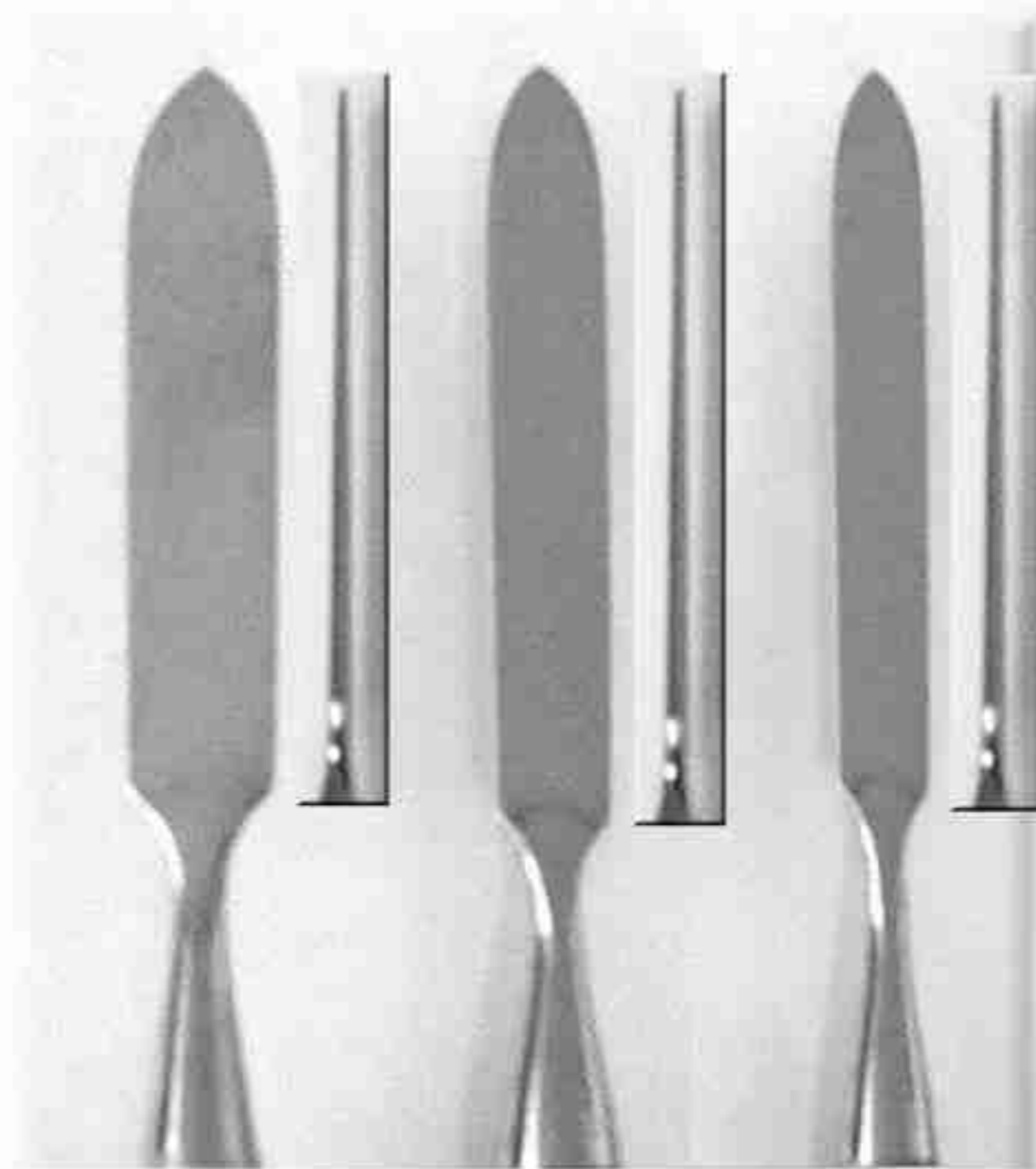

DF 1165
7.5mm

DF 1163
6 mm

DF 1161
5 mm

KOMPOZIT TÖMŐMŰSZEREK TITANNITRID BEVONATTAL
COMPOSITE FÜLLUNGSINSTRUMENTE MIT TITANNITRIDBESCHICHTUNG -
COMPOSITE MODELLING INSTRUMENTS WITH TITANIUM NITRIDE
NON-STICK PROTECTIVE COATING



DT 11



DT 12



DT 13



DT 14



DT 15



DT 16



DT 17



DT 18



DT 19

FOGTÖMŐK - FÜLLUNGSINSTRUMENTE - FILLING INSTRUMENTS

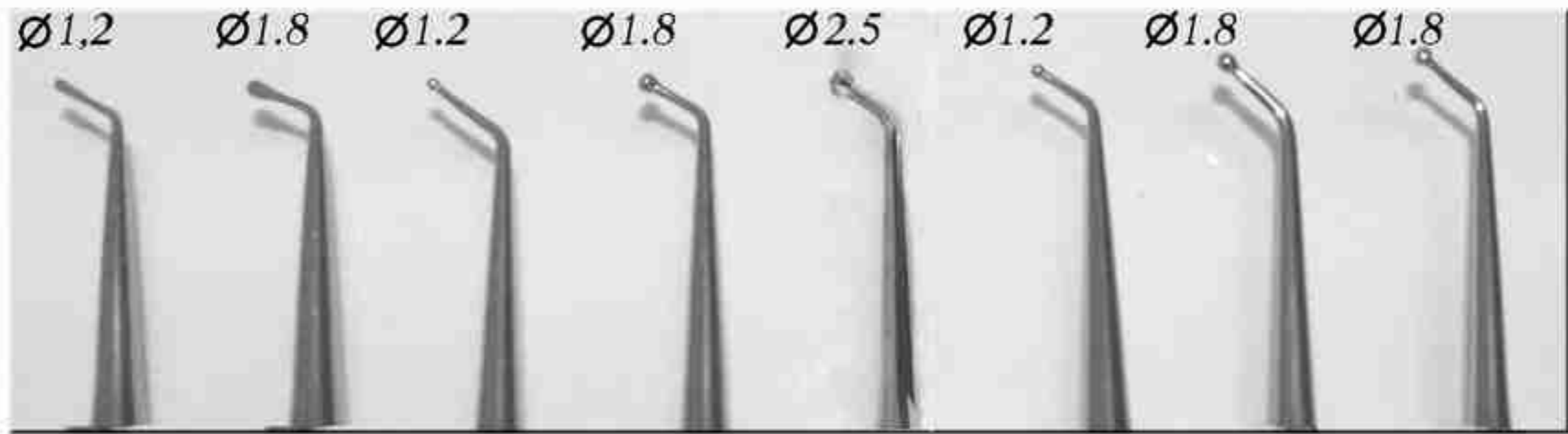

Ø1,2 Ø1,8 Ø1,2 Ø1,8 Ø2,5 Ø1,2 Ø1,8 Ø1,8

DE 14 DE 15 DE 16 DE 17 DE 20 DE 18 DE 19 DE 111

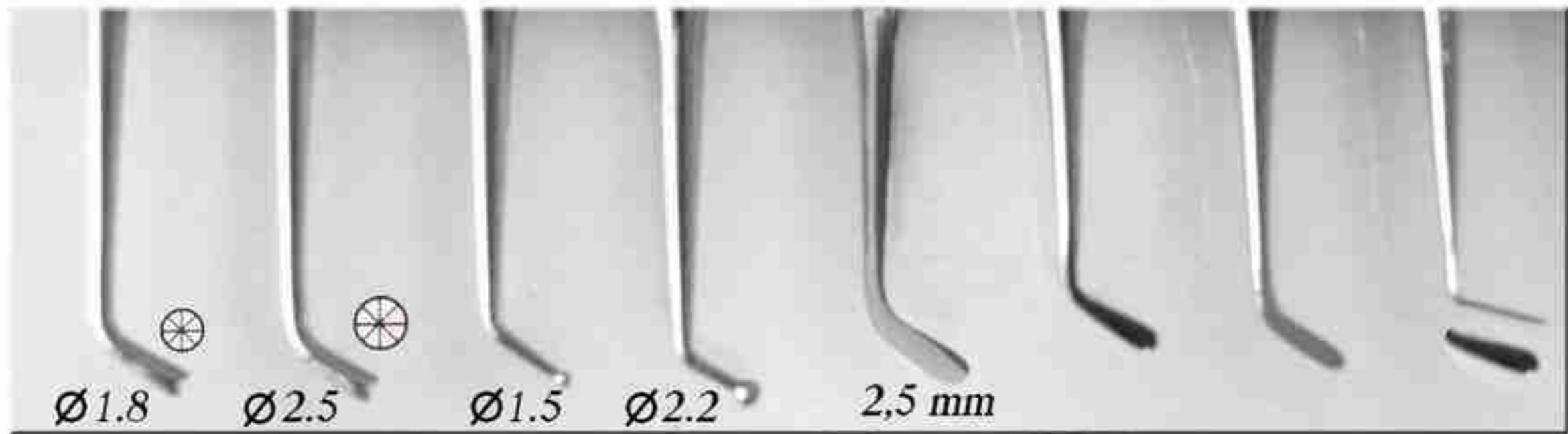

Ø1,8 Ø2,5 Ø1,5 Ø2,2 2,5 mm

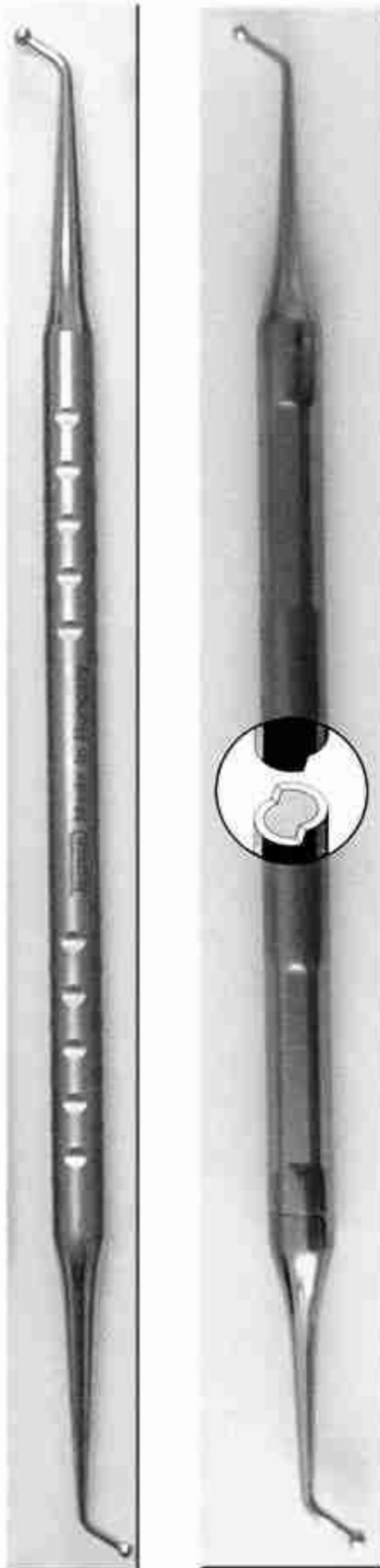

DE 17

.../HG

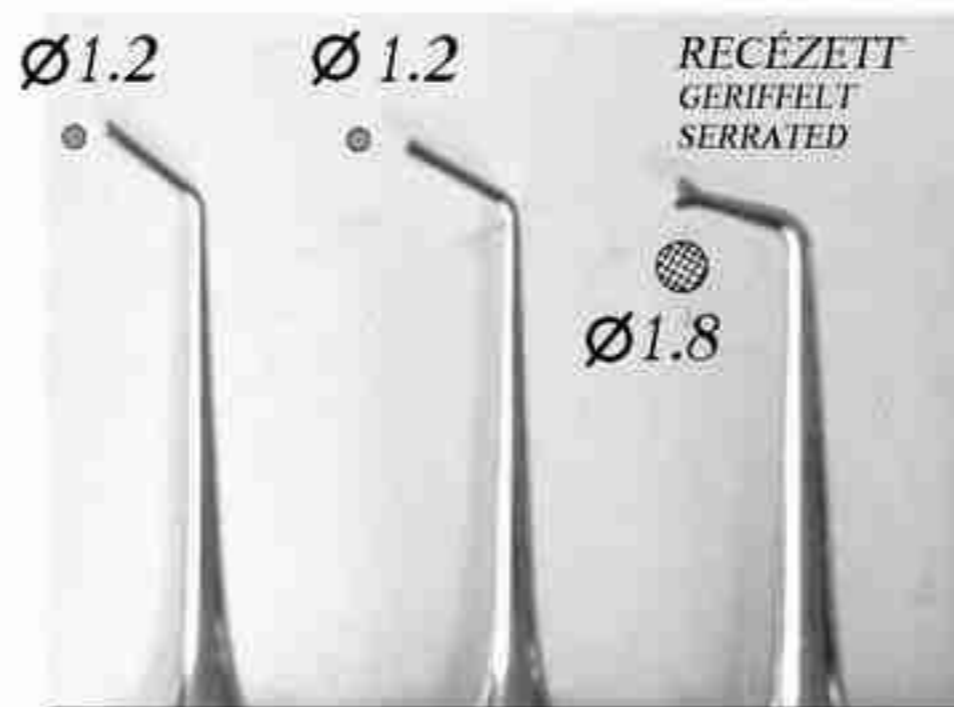

Ø1,2 Ø 1,2 RECÉZETT
GERIFFELT
SERRATED

Ø1,8

DE 124 DE 122 DE 1666

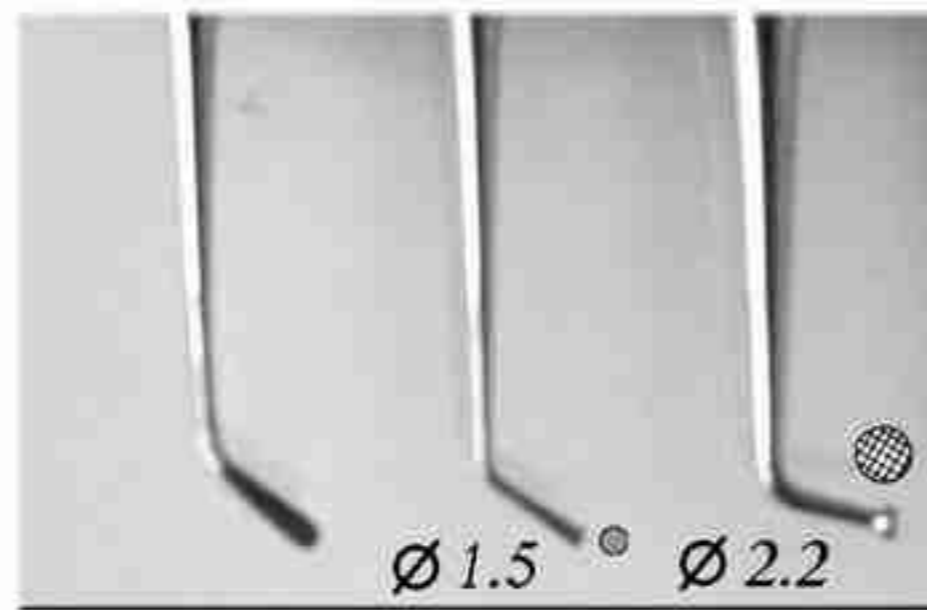

Ø 1,5 Ø 2,2

RECÉZETT
GERIFFELT
SERRATED

FOGTÖMŐK - FÜLLUNGSINSTRUMENTE - FILLING INSTRUMENTS

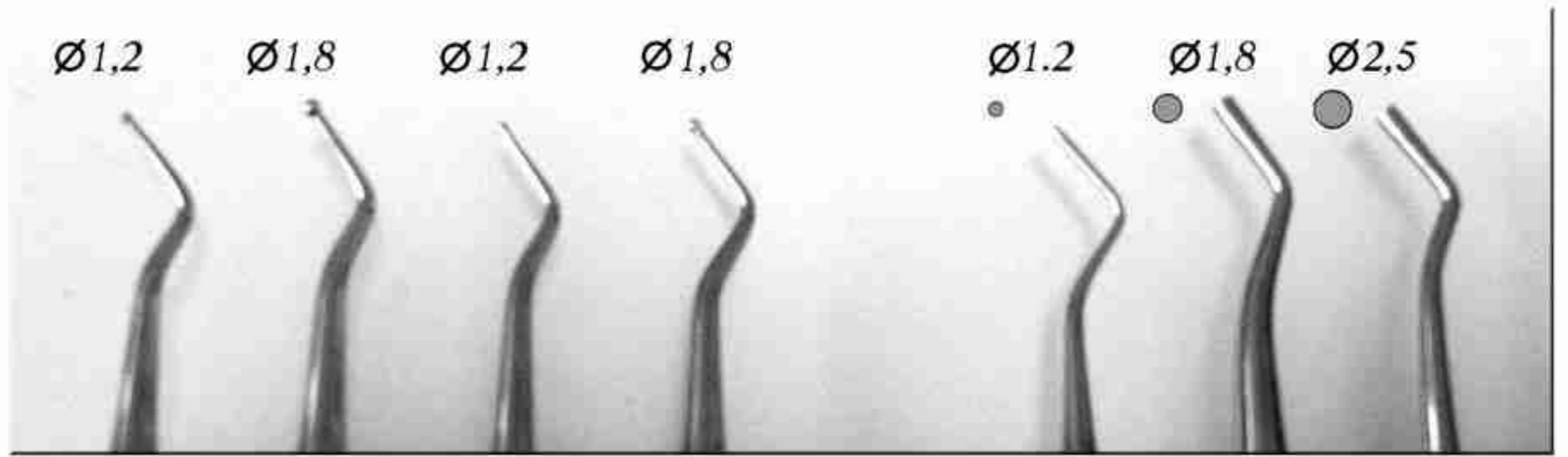

$\varnothing 1,2$ $\varnothing 1,8$ $\varnothing 1,2$ $\varnothing 1,8$ $\varnothing 1,2$ $\varnothing 1,8$ $\varnothing 2,5$
 DE 1110 DE 1111 DE 1113 DE 1114 DE 1125 DE 1126 DE 1127

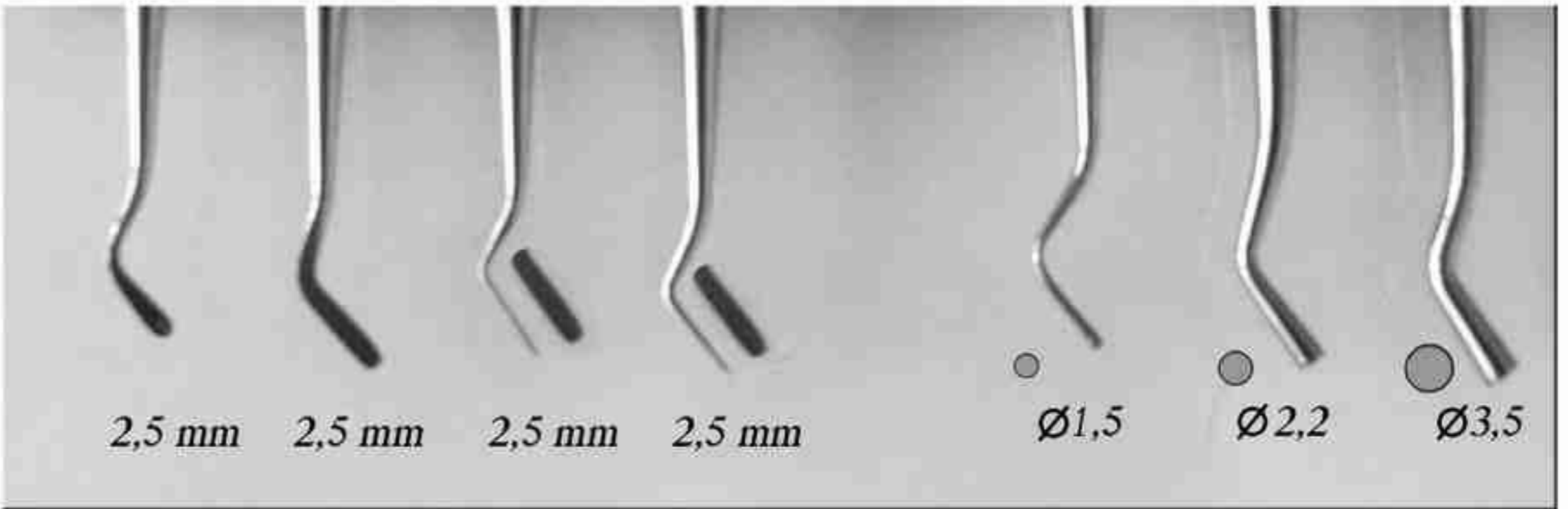

2,5 mm 2,5 mm 2,5 mm 2,5 mm $\varnothing 1,5$ $\varnothing 2,2$ $\varnothing 3,5$

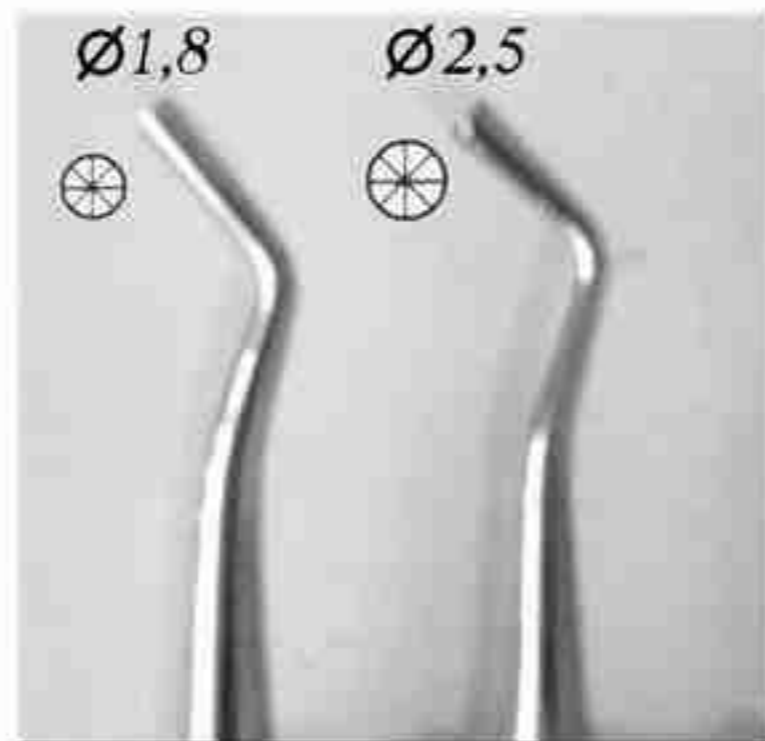

$\varnothing 1,8$ $\varnothing 2,5$
 DE 1101 DE 1102

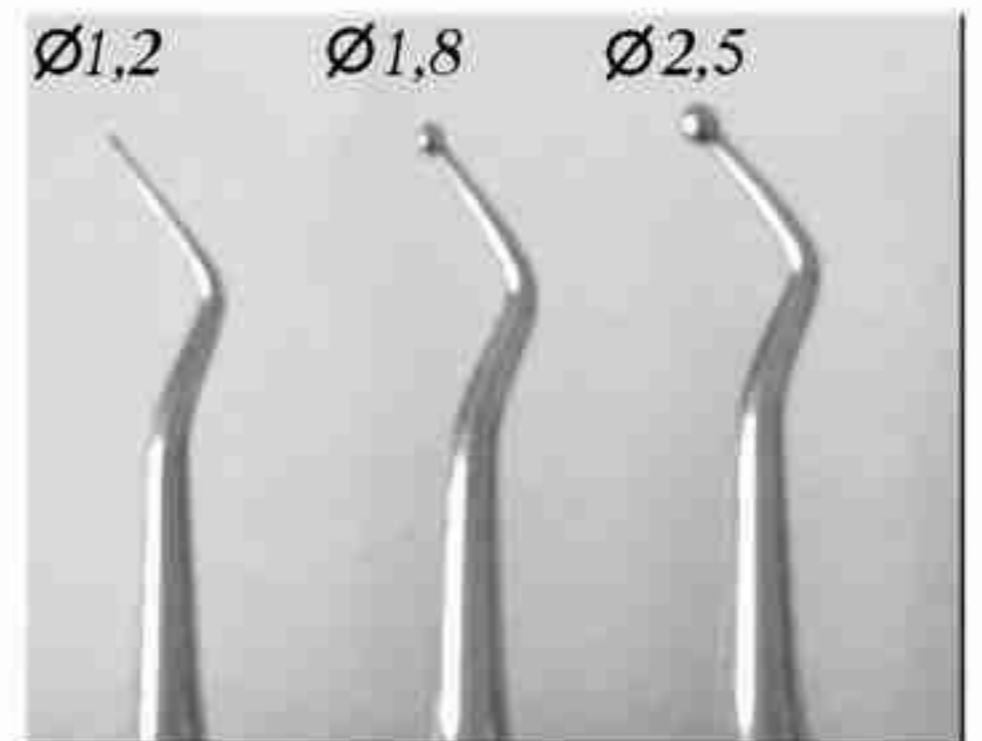

$\varnothing 1,2$ $\varnothing 1,8$ $\varnothing 2,5$
 DE 1107 DE 1108 DE 1109

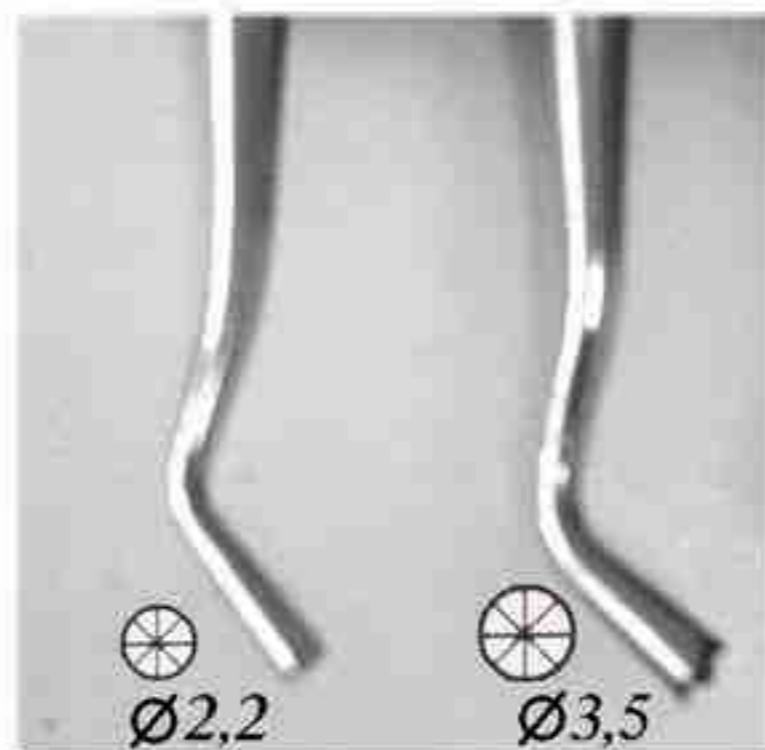

$\varnothing 2,2$ $\varnothing 3,5$

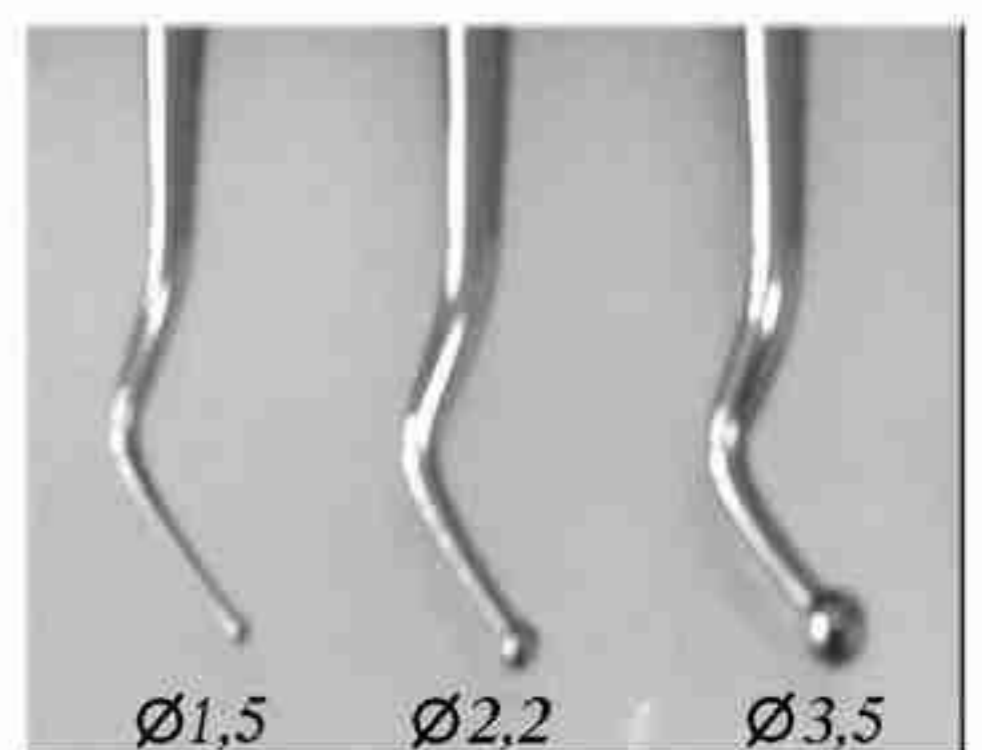

$\varnothing 1,5$ $\varnothing 2,2$ $\varnothing 3,5$

.../HG

FOGTÖMŐK - FÜLLUNGSINSTRUMENTE - FILLING INSTRUMENTS

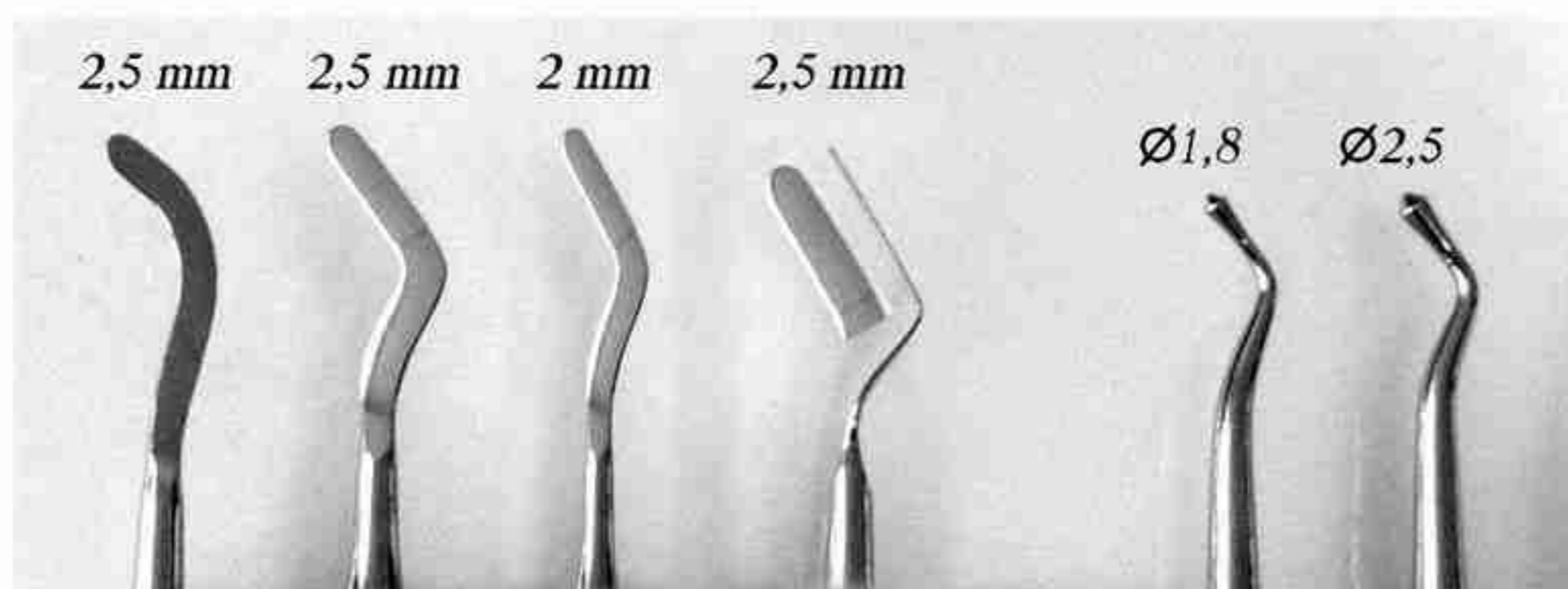

DE 1431 DE 1422 DE 1421 DE 1423 DF 121 DF 122

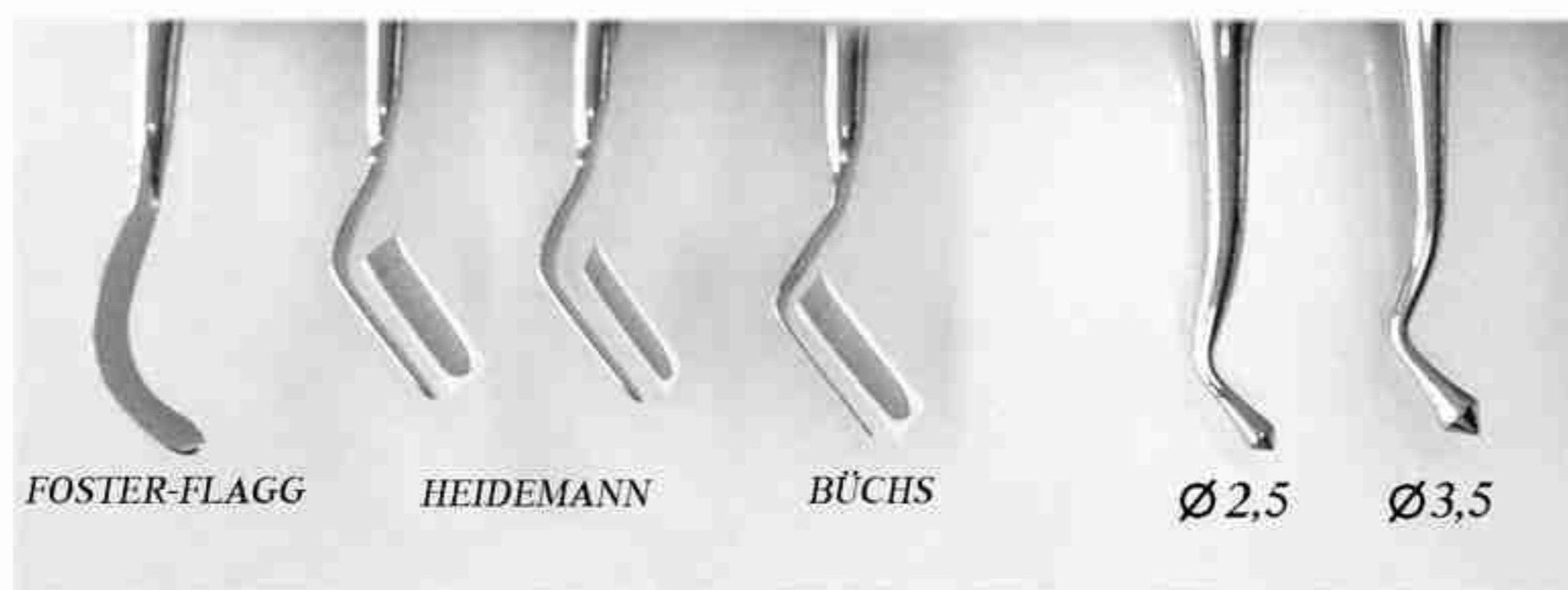

.../HG

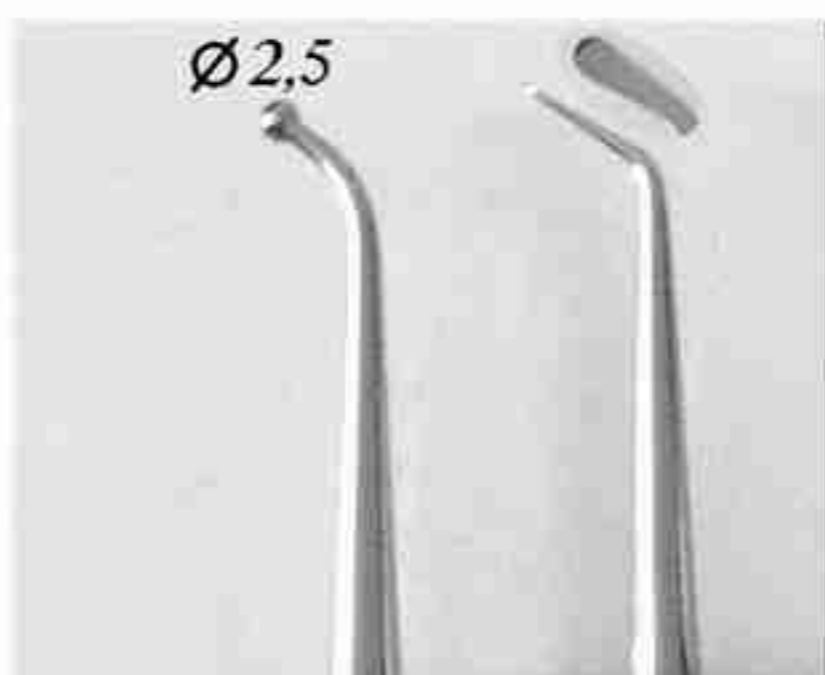

DE 1297 DE 130



GYÖKÉRTÖMŐK -

NERVEN INSTRUMENTE - NERVE INSTRUMENTS

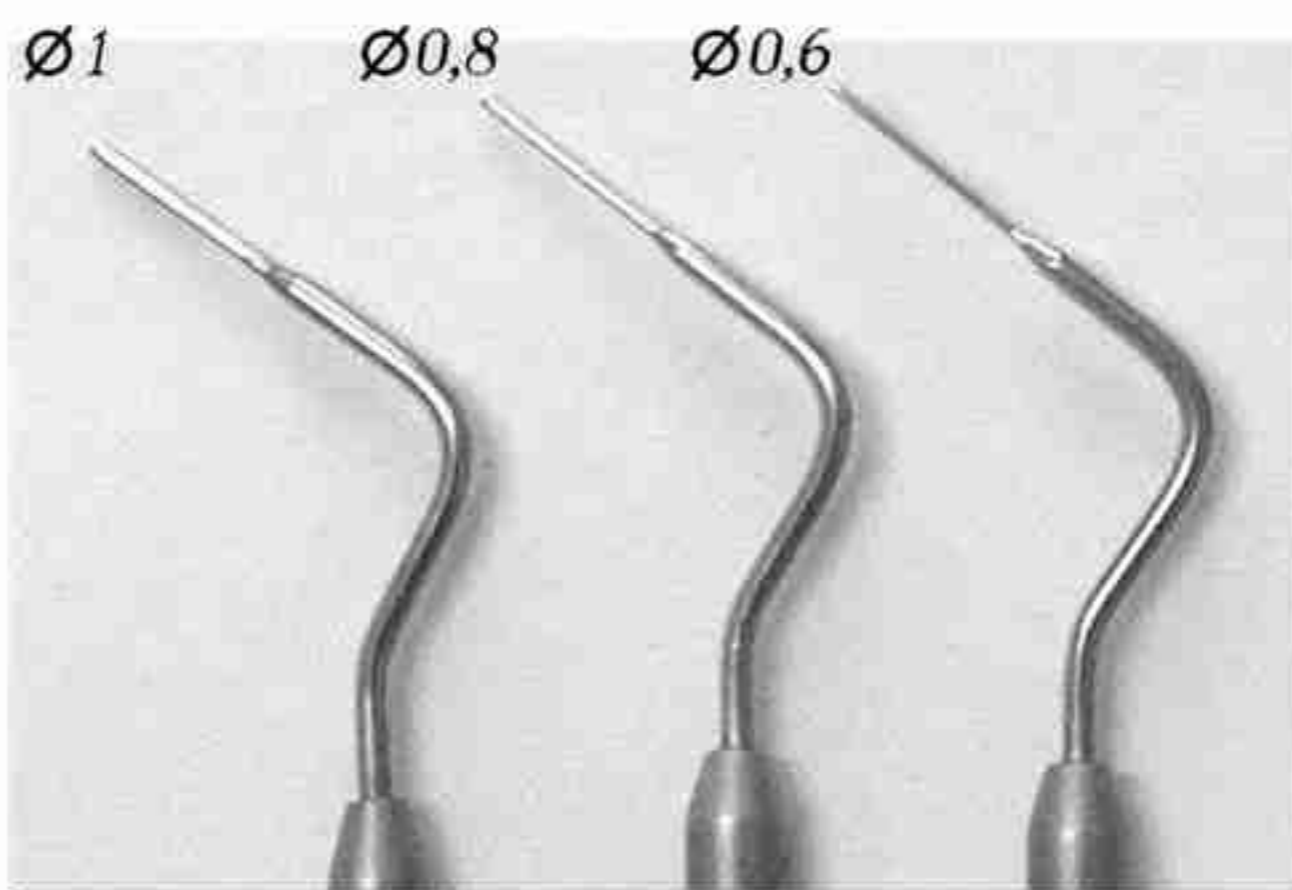

DD 9 DD 8 DD 7



DO 1305

DO 1301

Luniatschek
18.5 cm

TAMPONVIVÓ
TAMPONSTOPFER
GAUZE PACKER

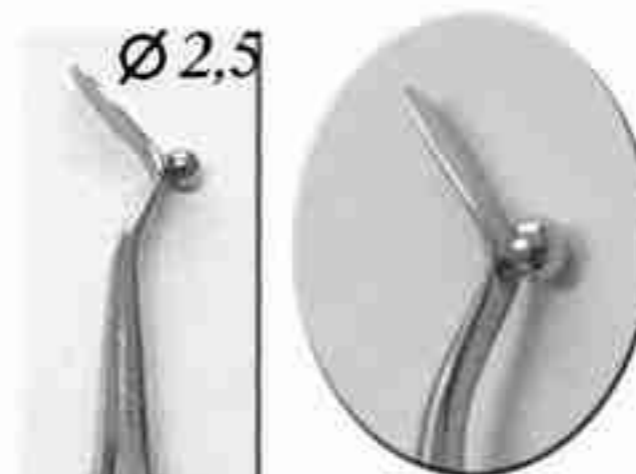

Ø2.5

Vajna

Ø 1.8

DF 100
TÖMŐ-SIMITÓ
FÜLLUNGSINSTRUMENTE
FILLING INSTRUMENTS



.../HG



DF 116

AMALGÁM PISZTOLY
AMALGAM PISTOLE
AMALGAM CARRIERS

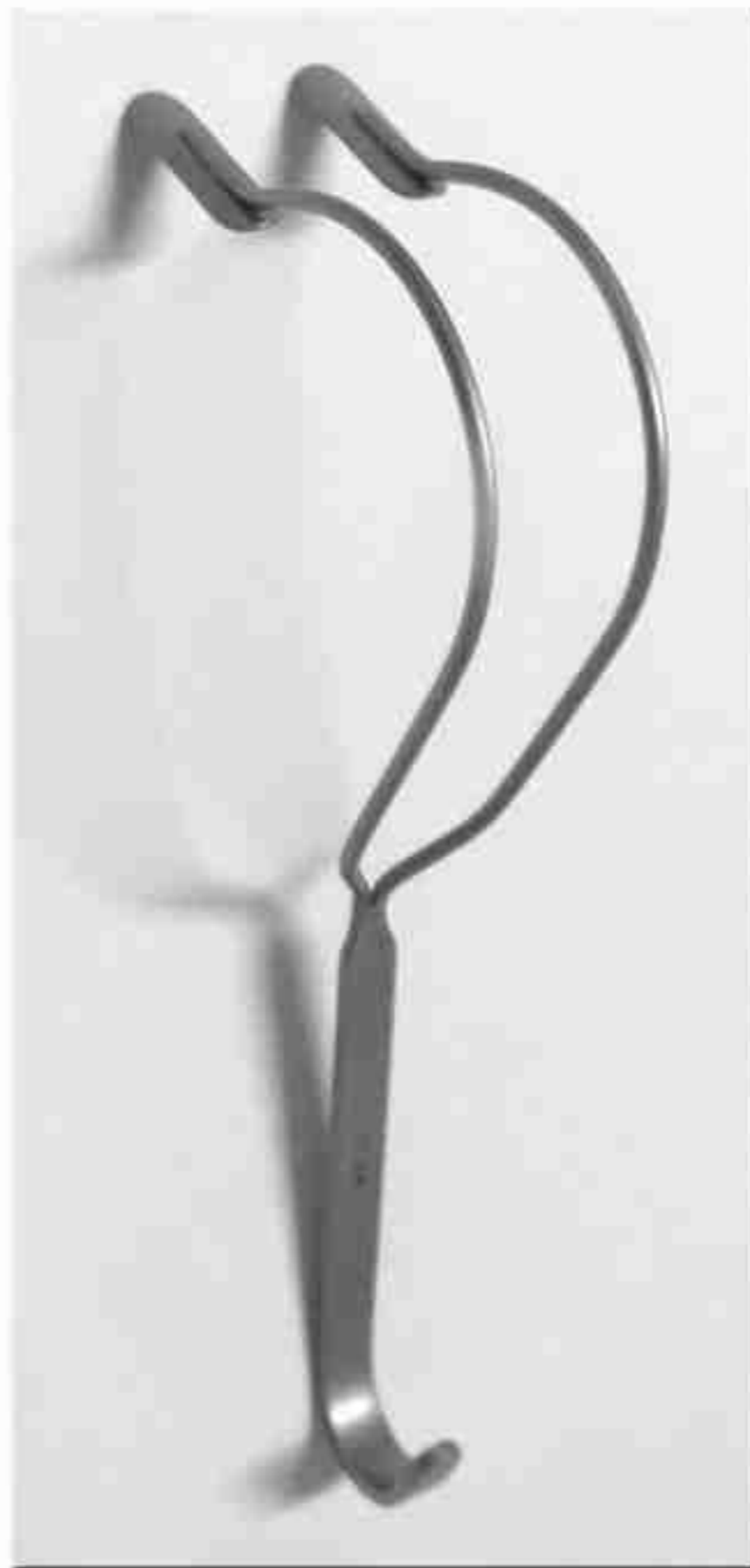

DD 10

VATTATEKERCS LESZORÍTÓ
WATERROLLENHALTER
COTTON PUSHER



DO 1306
FONALBEVIVŐ
FADENSTOPFER
RETRACTION
PACKER



DF 1346 5 mm

DF 1348 7 mm

MATRICAFESZÍTŐ
MATRIZEN SPANNER
MATRIX RETAINERS



DF 1349

MATRICAFESZÍTŐ
MATRIZEN SPANNER
MATRIX RETAINERS IVORY

EXKAVÁTOROK - EXKAVATOREN - EXCAVATORS

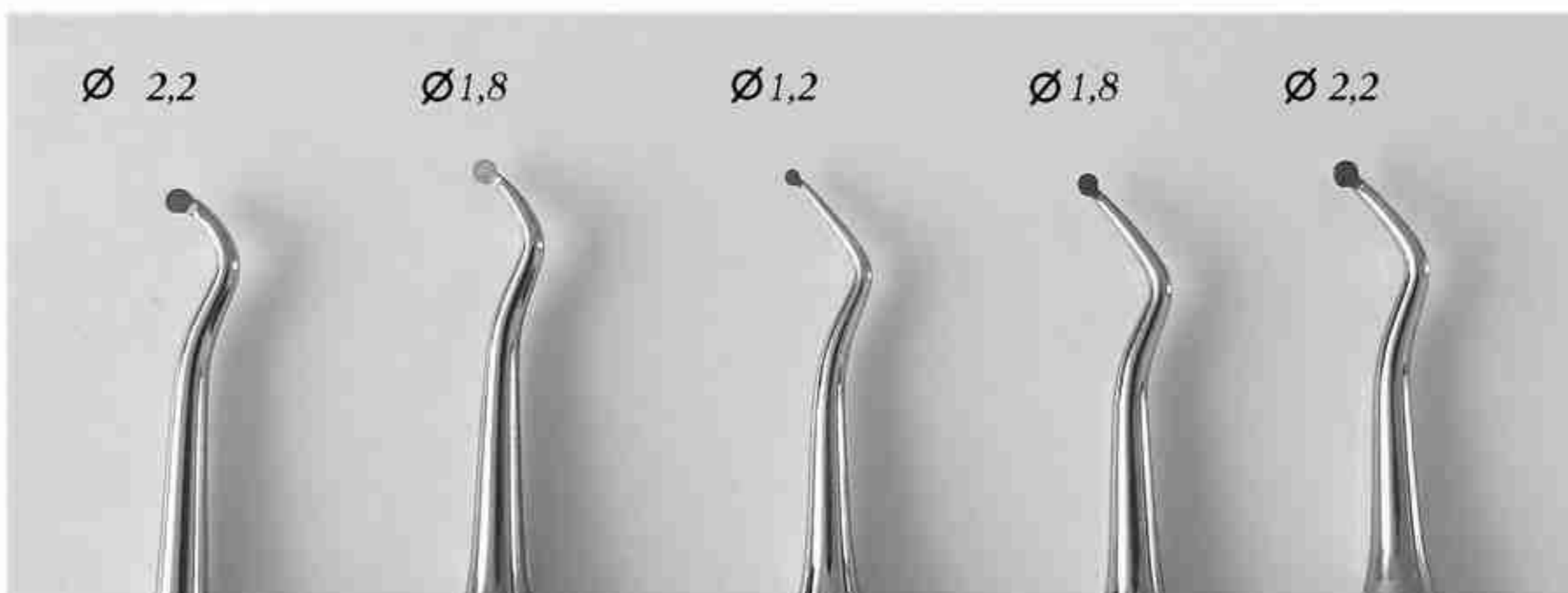

DC 1239 DC 1241 DC1271 DC 1275 DC1279

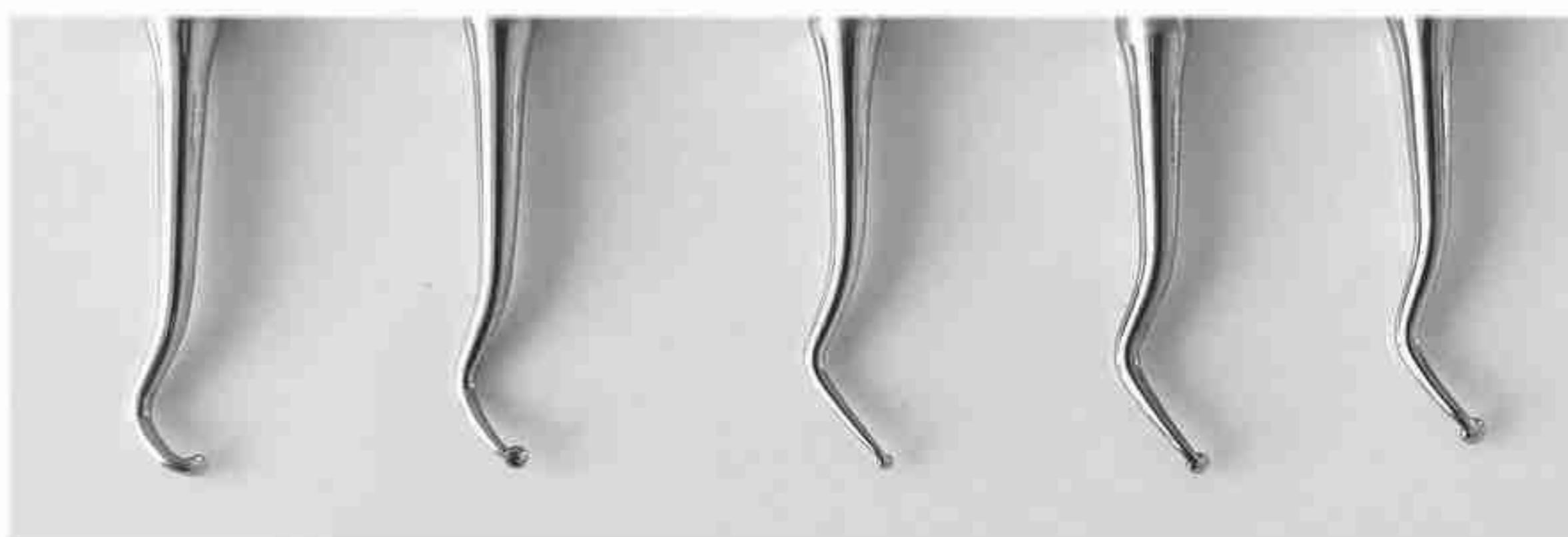

.../HG



OM 13
31mm



OM 12
28mm



OM 11
25mm

UJJVÉDŐ, FÉM
FINGERSCHÜTZER, METALL
FINGER PROTECTOR

FOGHÚSSZÉL-KÉSEK -

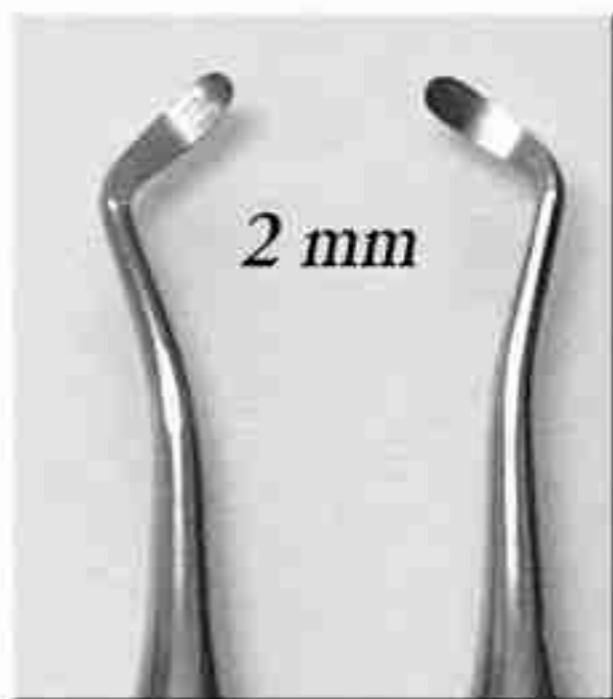

2 mm

DC 161 DC 162

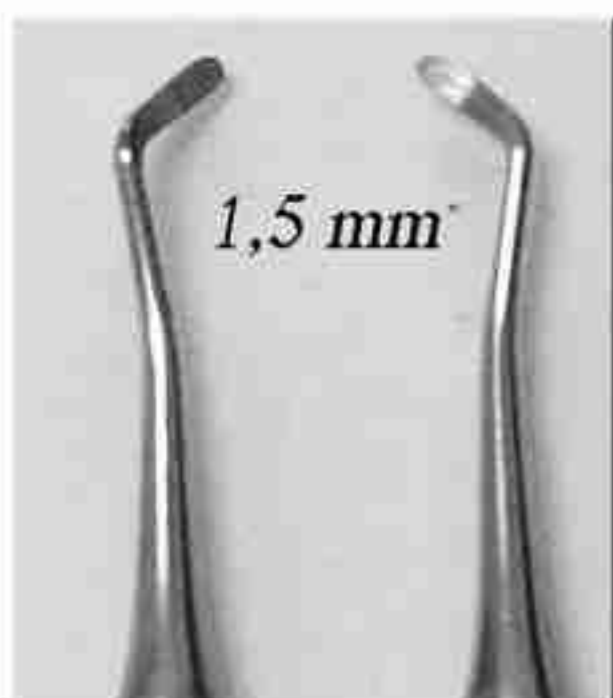

1,5 mm

DC 163 DC 164

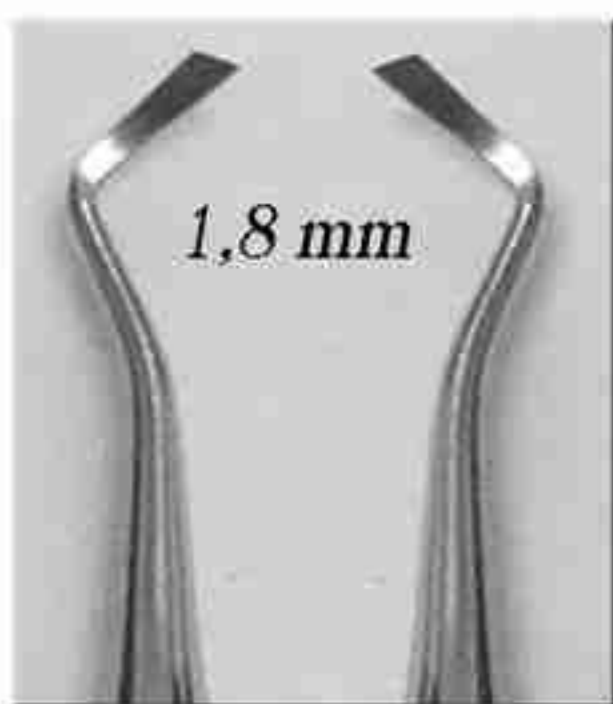

1,8 mm

DC 177 DC 178

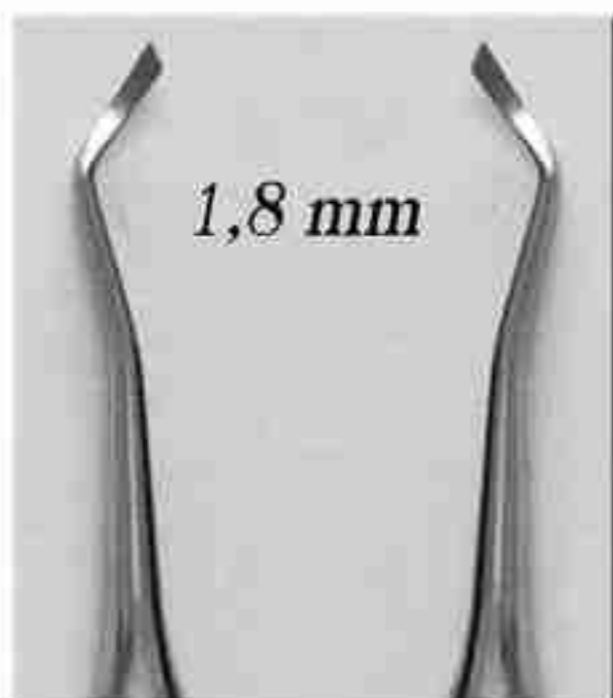

1,8 mm

DC 179 DC 180

ZAHNFLEISCHMESSER
BLACK CUTTING
INSTRUMENTS

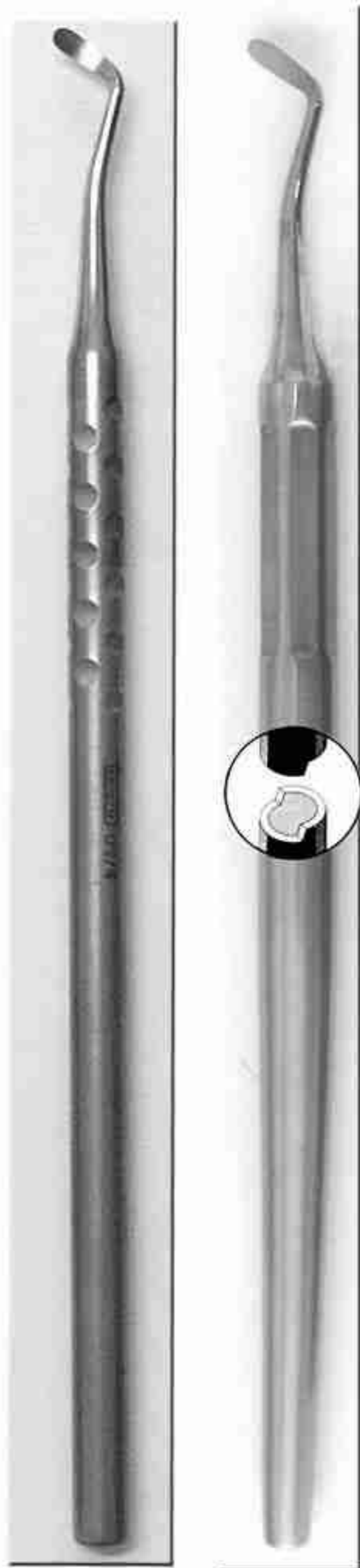

.../HG

ZOMÁNC VÉSŐK - SCHMELZMEISSEL
ENAMEL CHISELS

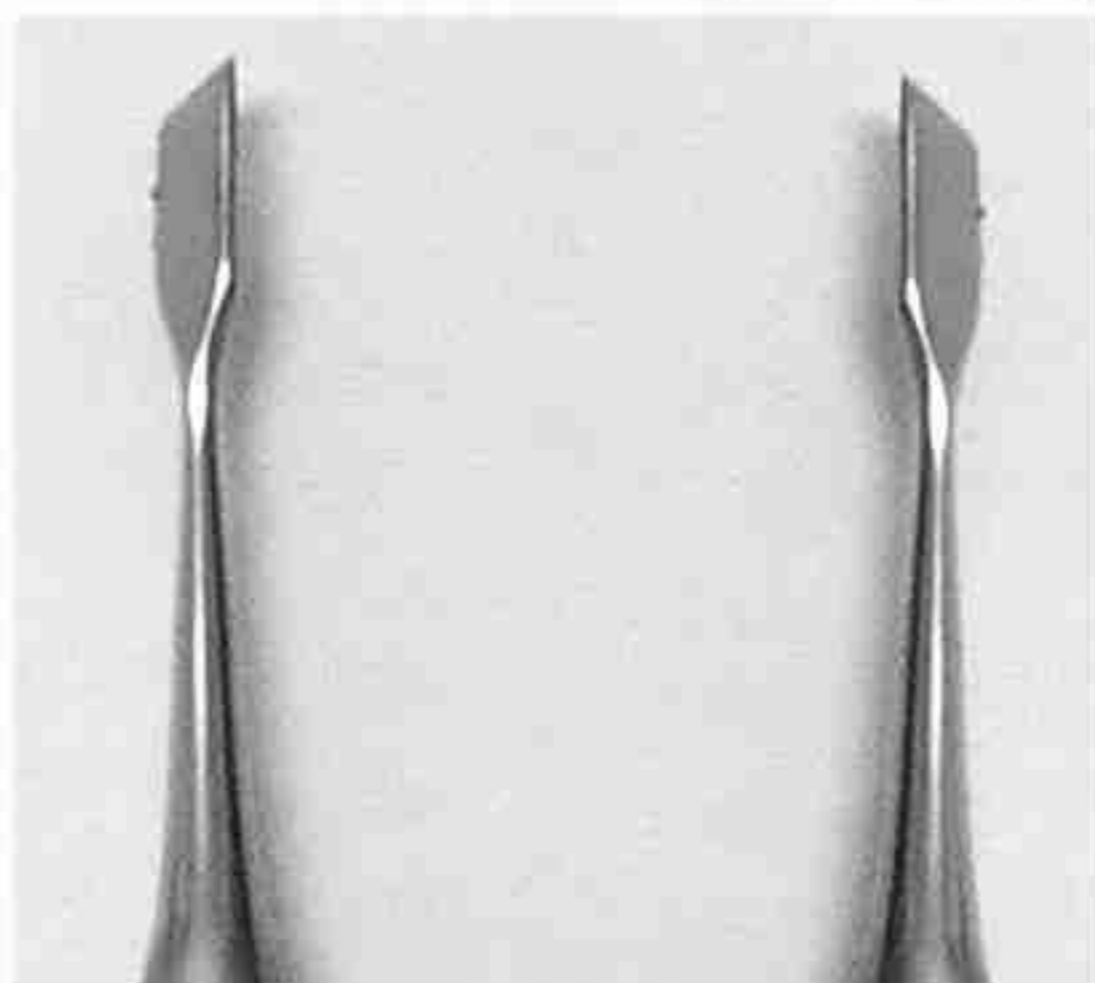

DC 151 3 mm DC 152



DC 181 3 mm

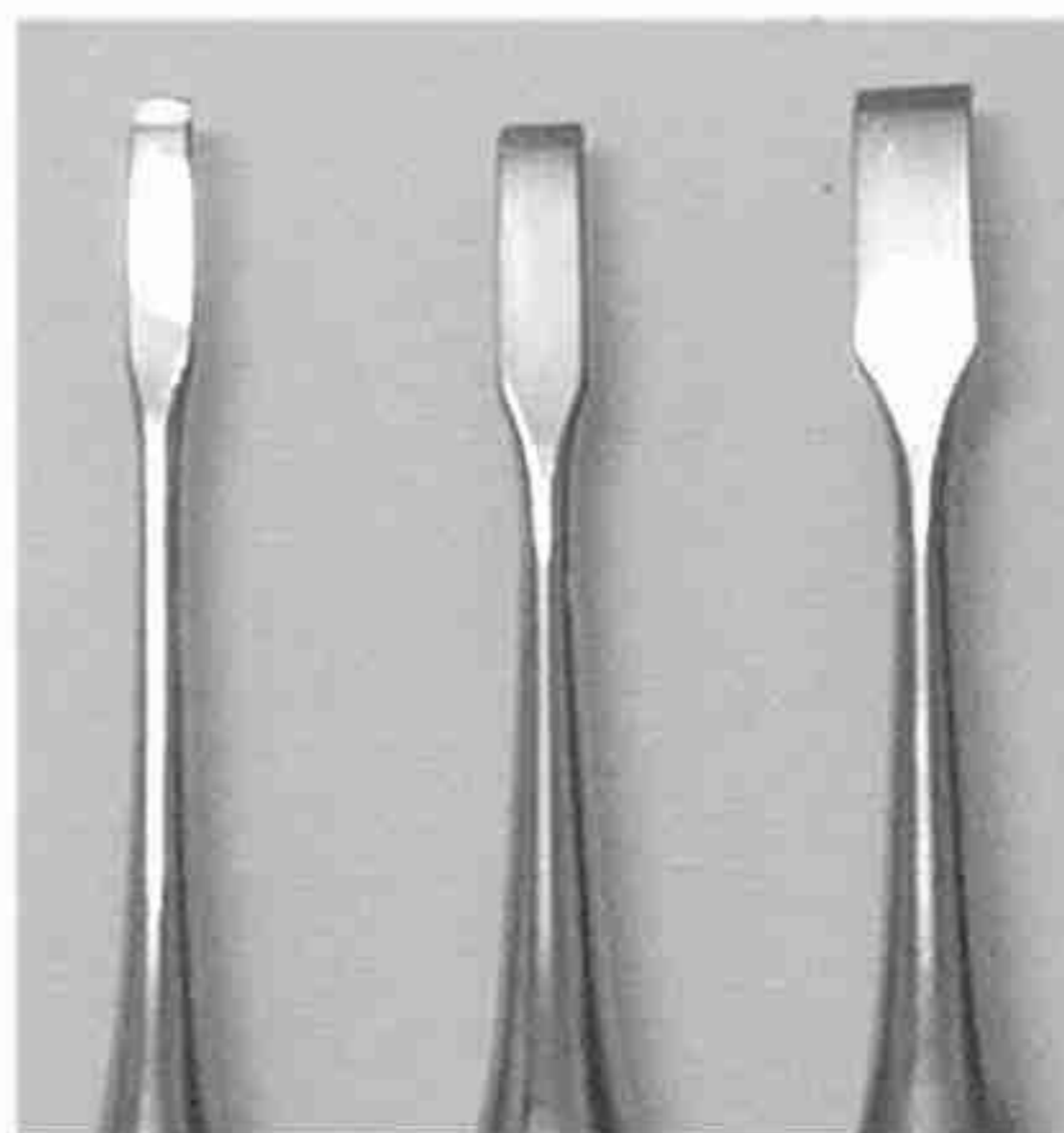

DC 185 2 mm DC 184 3 mm DC 183 4 mm

ÉRFOGÓK - ARTERIENKLEMMEN - HAEMOSTATIC FORCEPS

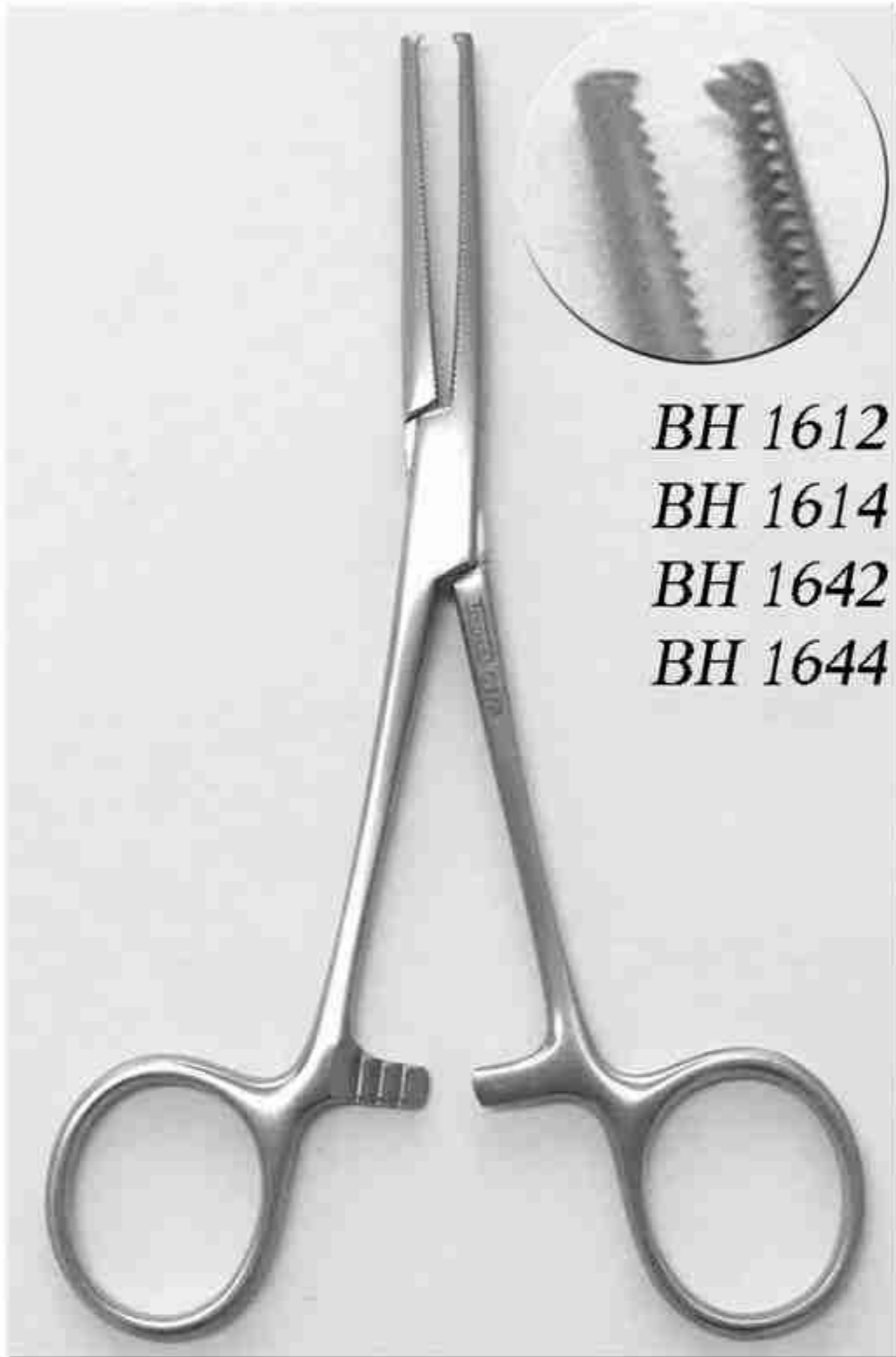

EGYENES HORGAS
GERADE MIT ZAHNE
STRAIGHT WITH HOOK

- BH 1612 HALSTED MOSQUITO 12.5 cm
- BH 1614 CRILE 14 cm
- BH 1642 CRILE 16 cm
- BH 1644 HALSTED 18 cm

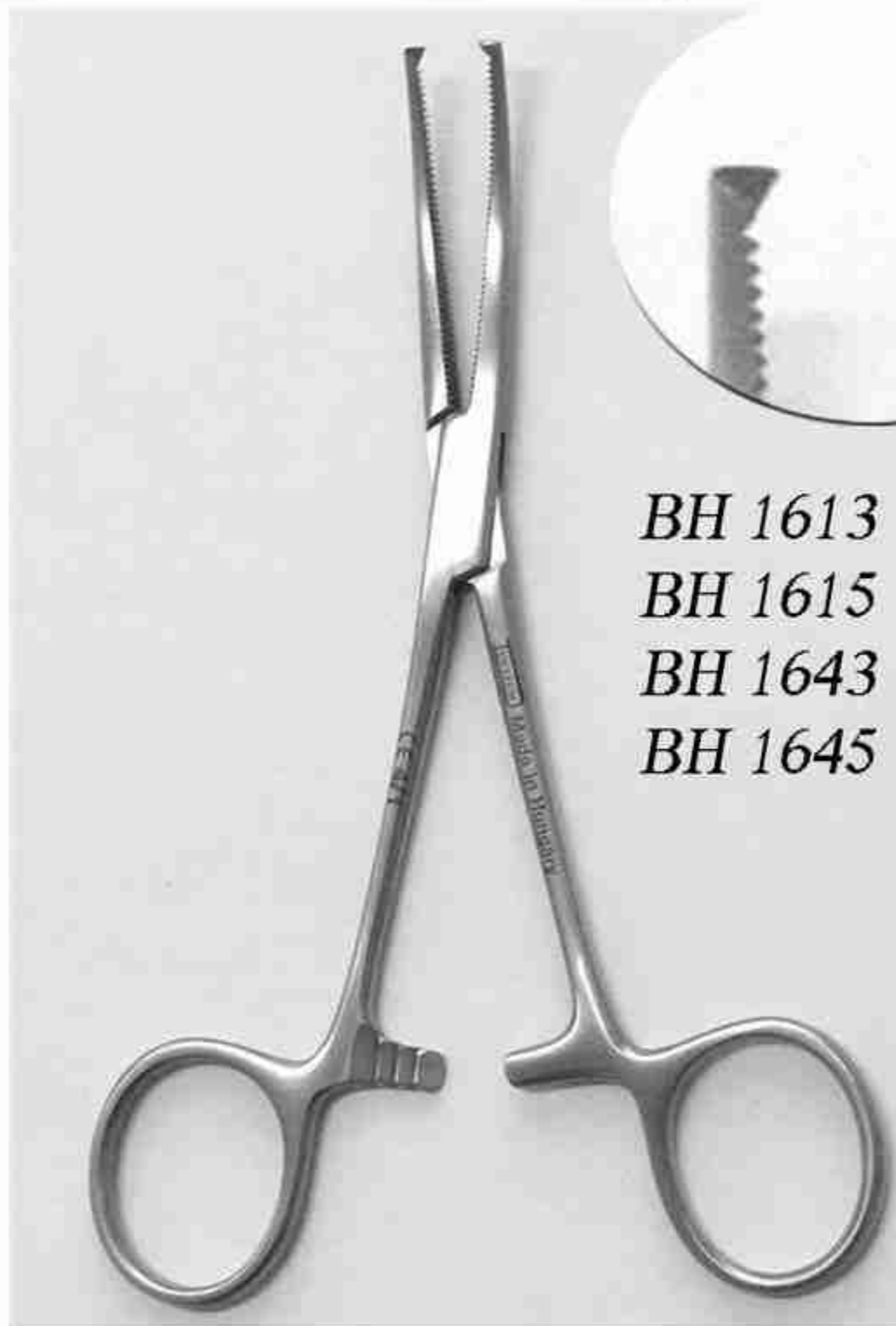

HAJLÍTOTT HORGAS
GEBOGEN MIT ZAHNE
CURVED WITH HOOK

- BH 1613 HALSTED MOSQUITO 12.5 cm
- BH 1615 CRILE 14 cm
- BH 1643 CRILE 16 cm
- BH 1645 HALSTED 18 cm

ÉRFOGÓK - ARTERIENKLEMMEN - HAEMOSTATIC FORCEPS

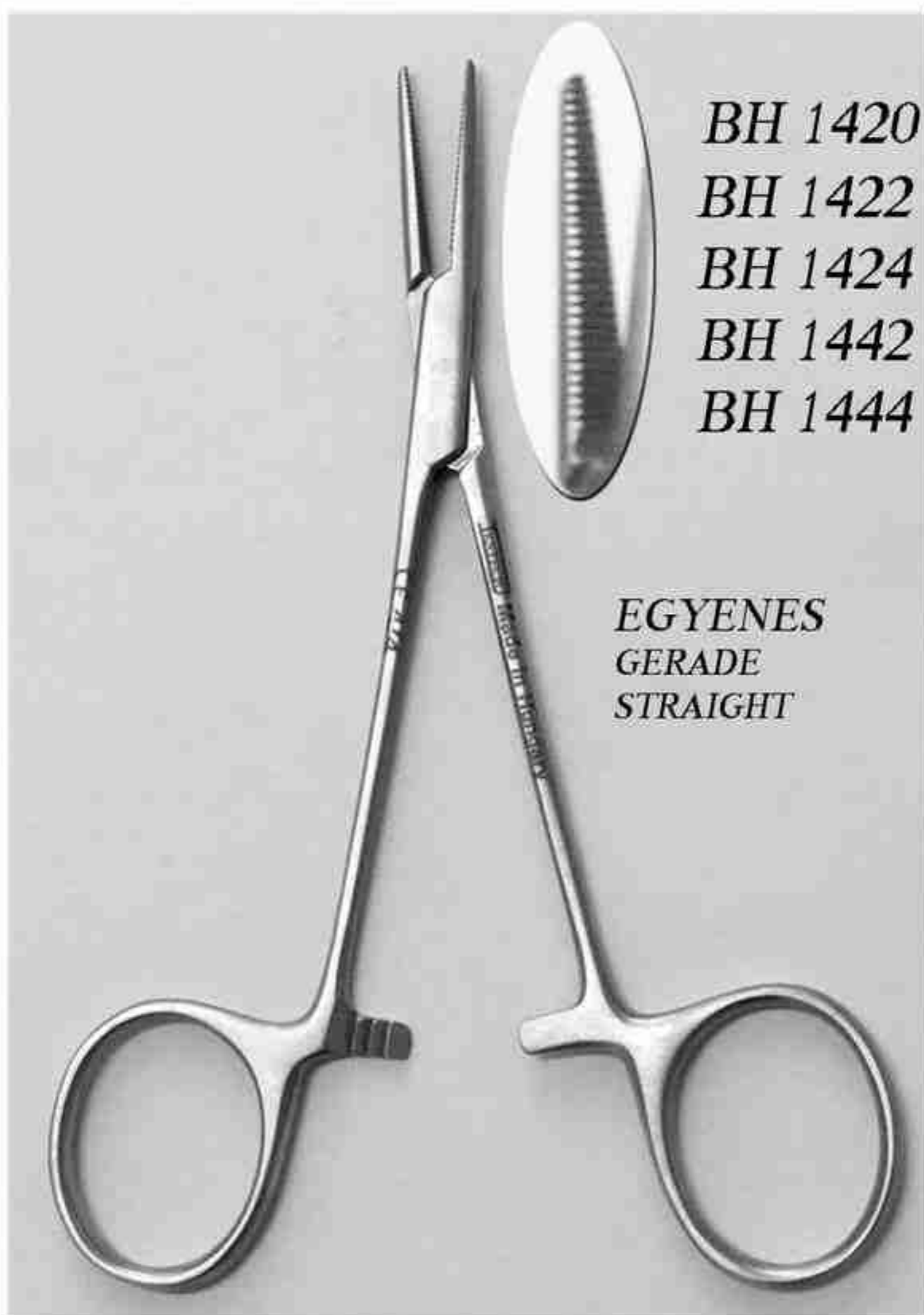

EGYENES
GERADE
STRAIGHT

BH 1420
BH 1422
BH 1424
BH 1442
BH 1444

BABY MOSQUITO 10 cm
HALSTED MOSQUITO 12.5 cm
CRILE 14 cm
CRILE 16 cm
HALSTED 18 cm

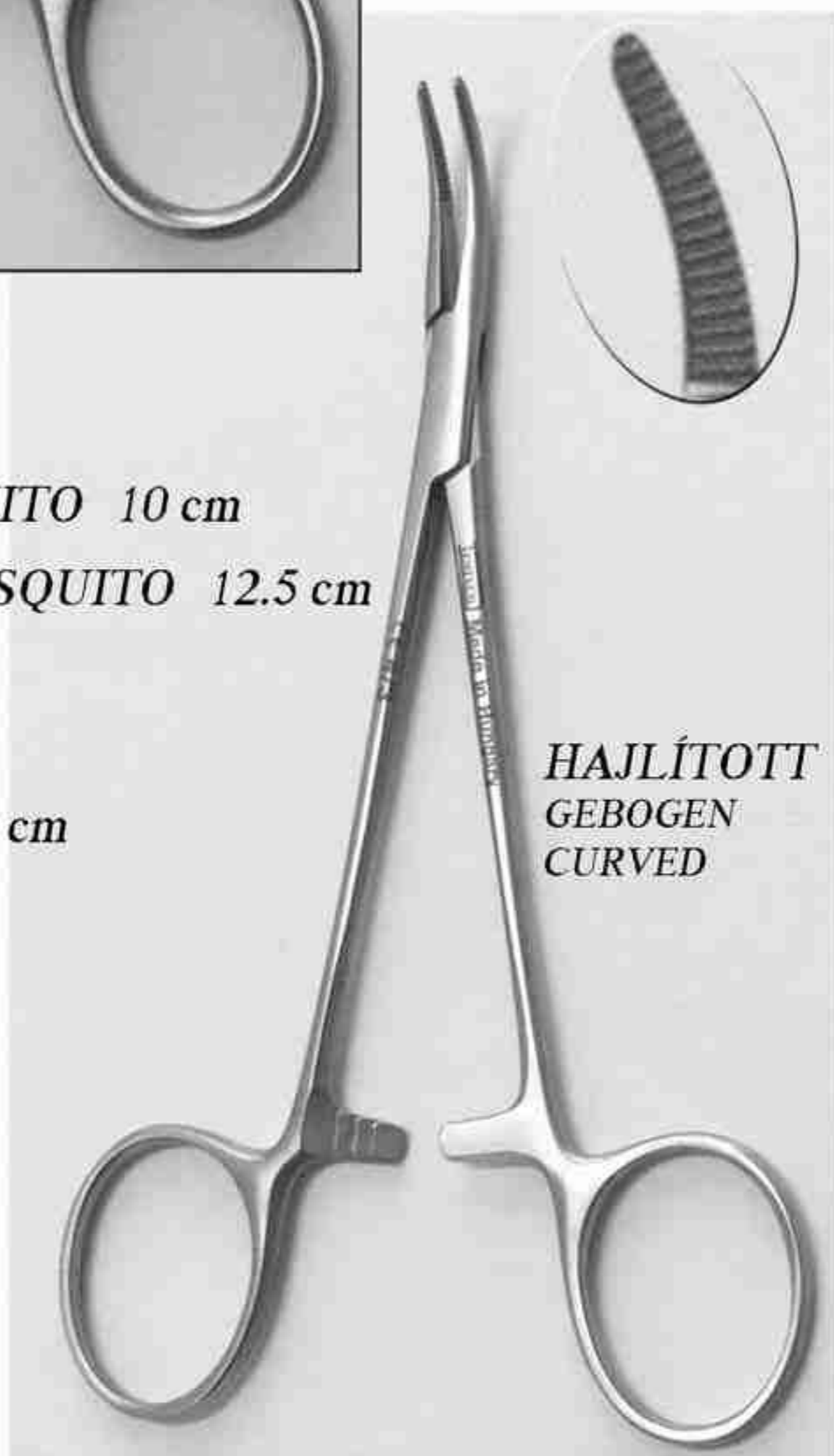

HAJLÍTOTT
GEBOGEN
CURVED

BH 1421 BABY MOSQUITO 10 cm
BH 1423 HALSTED MOSQUITO 12.5 cm
BH 1425 CRILE 14 cm
BH 1443 CRILE 16 cm
BH 1445 HALSTED 18 cm

SZEMÉSZETI SZIKÉK - AUGENSKALPELLE - SCALPELS

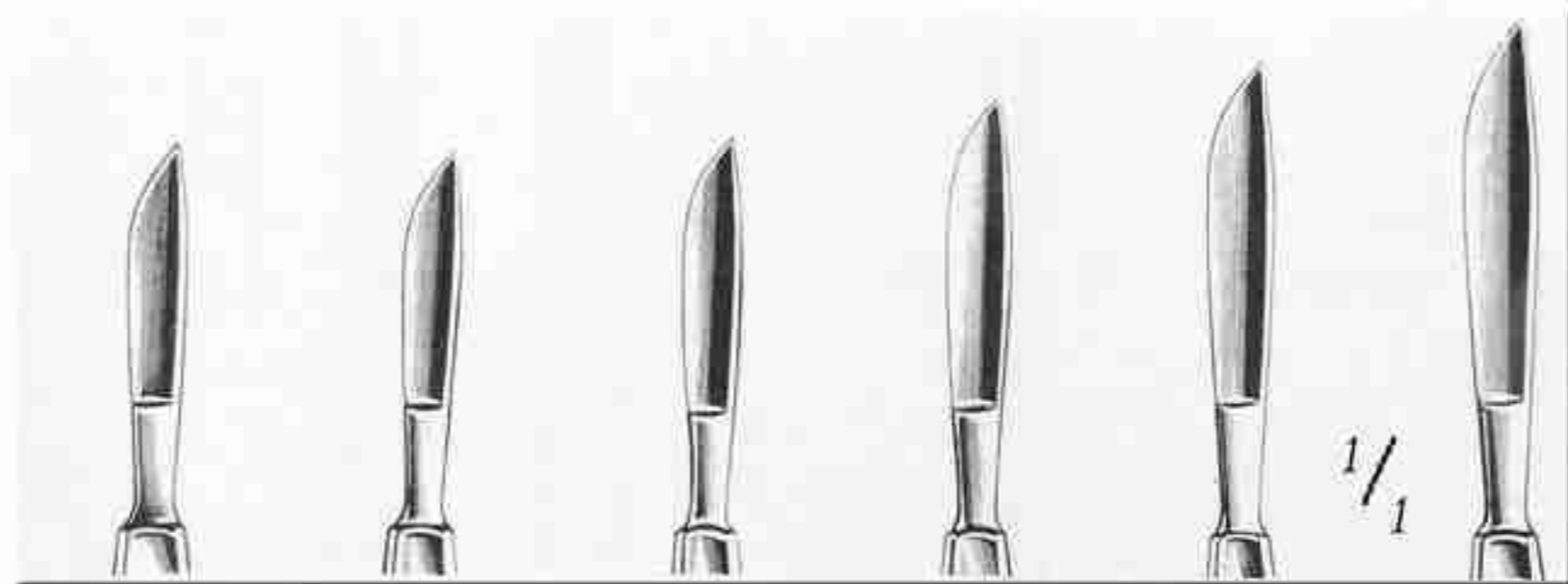

BA 1401 BA 1402 BA 1403 BA 1404 BA 1407 BA 1408

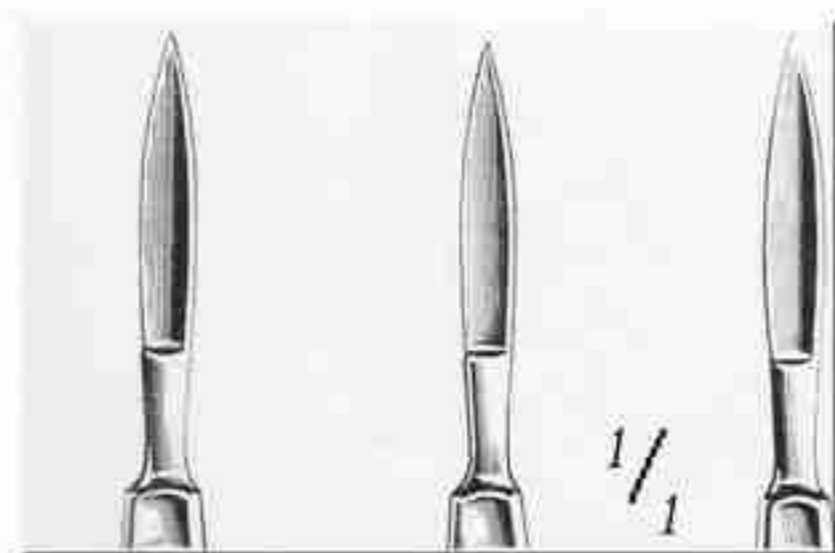

BA 1409 BA 1410 BA 1411



SEBÉSZETI SZIKÉK - CHIRURGISCHE SKALPELLE - SURGERY KNIVES

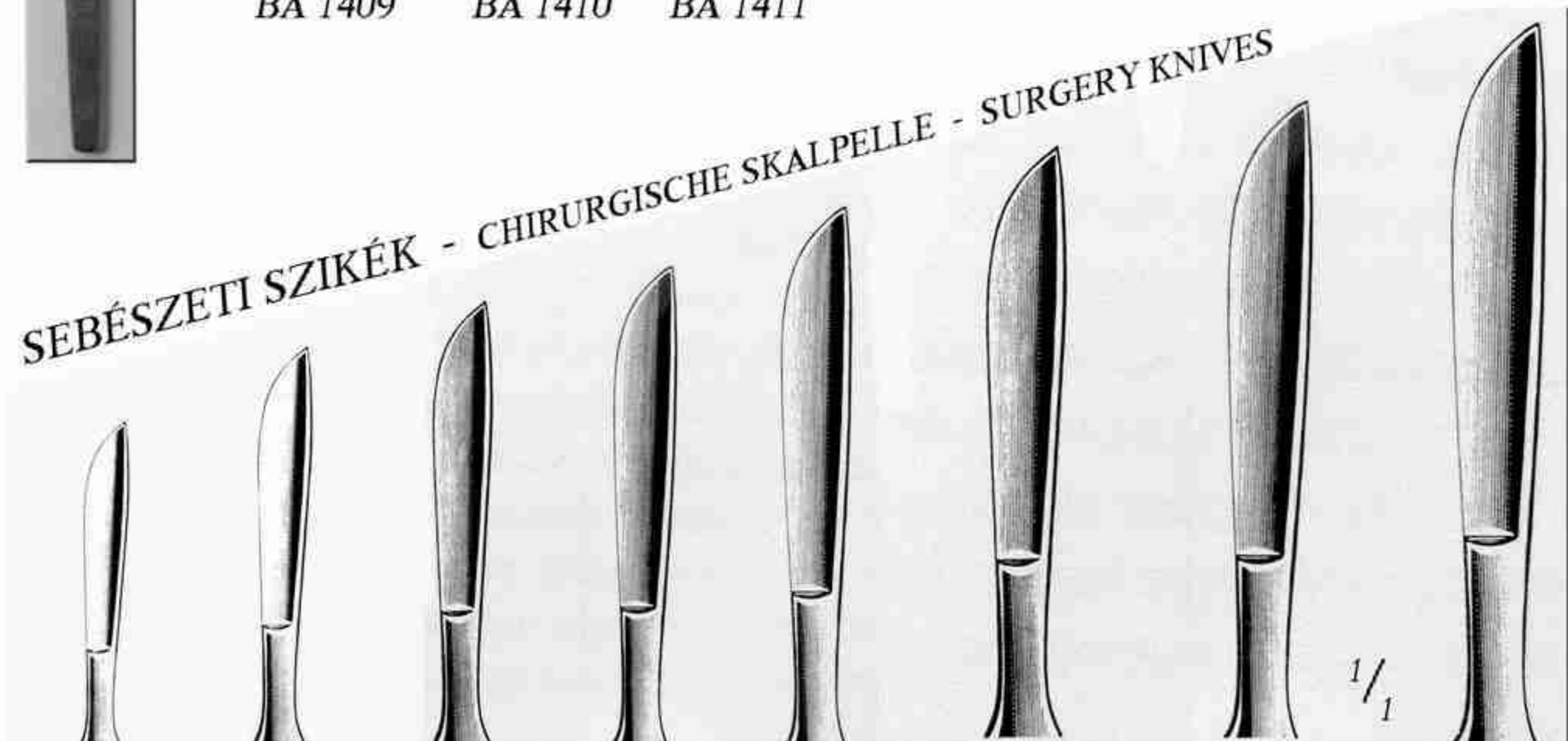

BA 1501 BA 1502 BA 1503 BA 1504 BA 1505 BA 1507 BA 1508 BA 1509

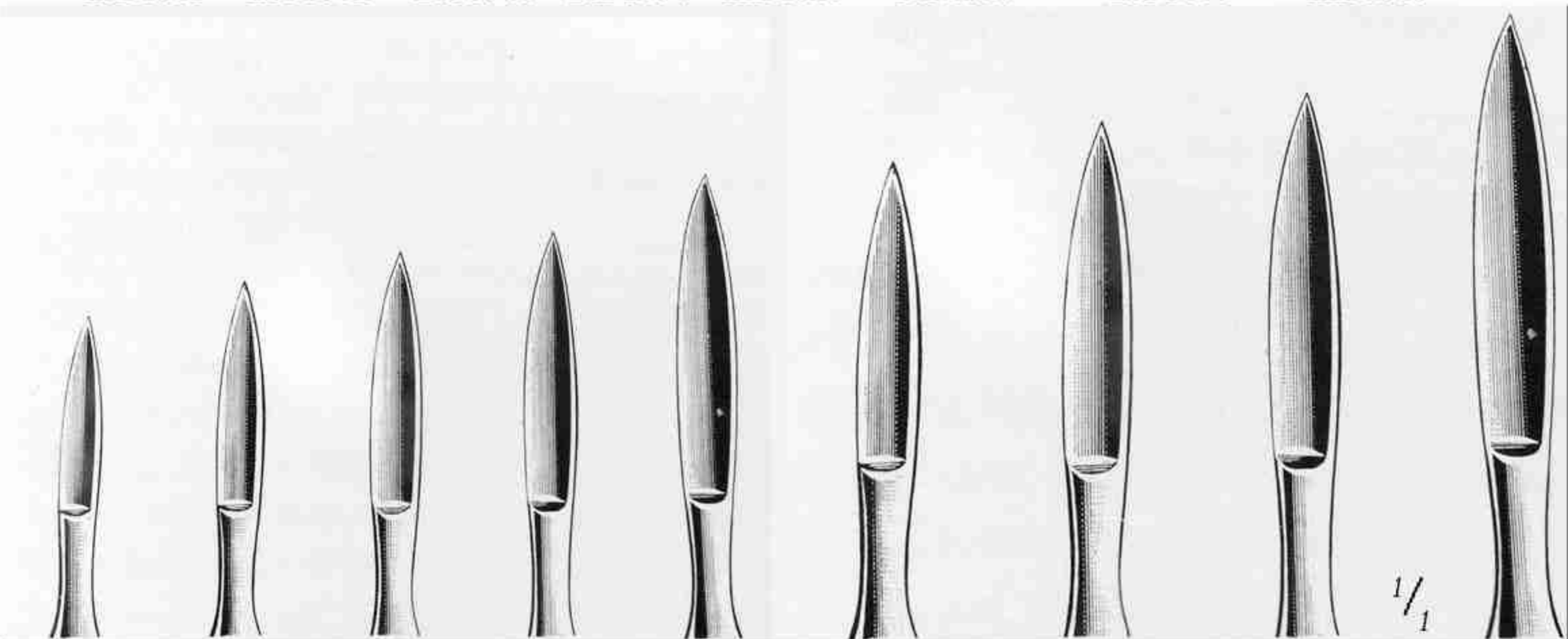

BA 1510 BA 1511 BA 1512 BA 1513 BA 1514 BA 1515 BA 1516 BA 1517 BA 1518

FOGHÚZÓ FOGÓK - ZAHNZANGE - EXTRACTING FORCEPS

DG 50/...

DG 40/...



1



2

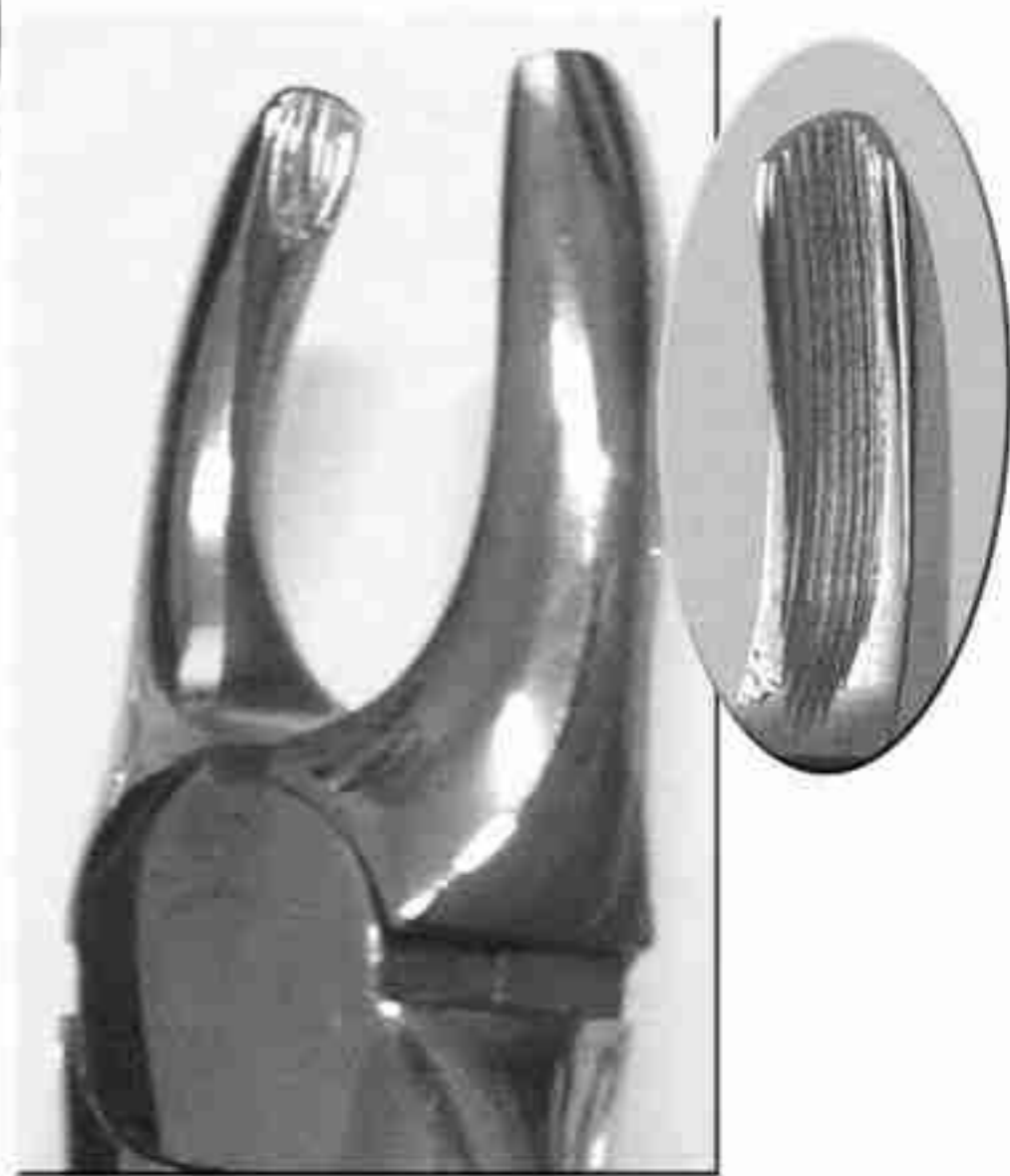

3

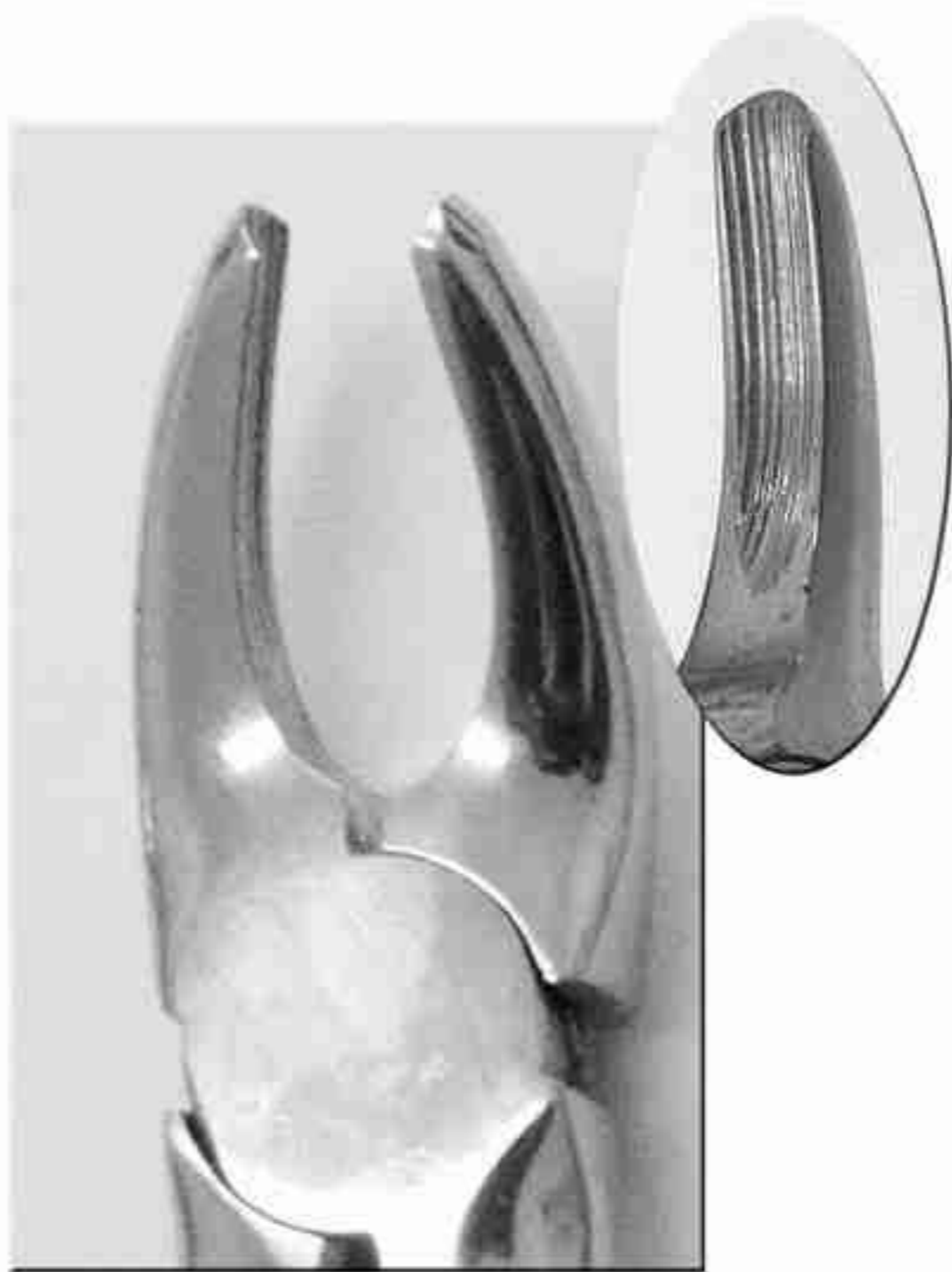

7



8



13

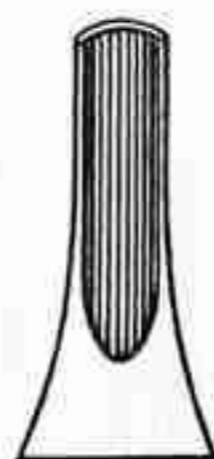

4

FOGHÚZÓ FOGÓK - ZAHNZANGE - EXTRACTING FORCEPS

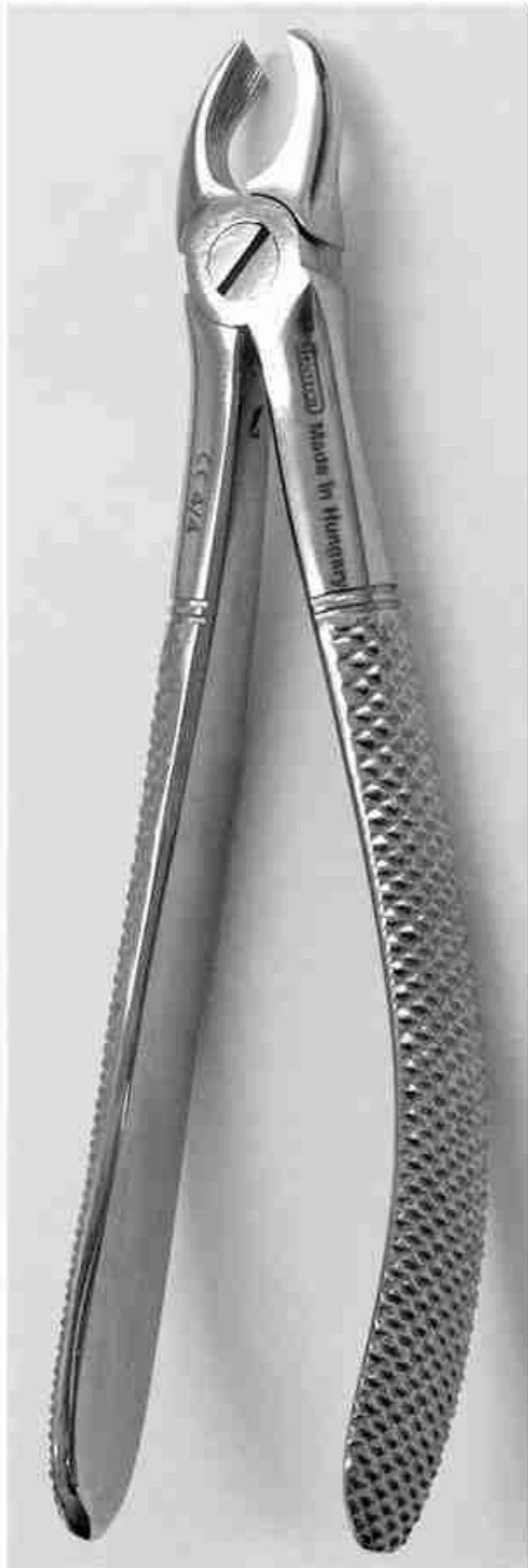

18

DG 40/...

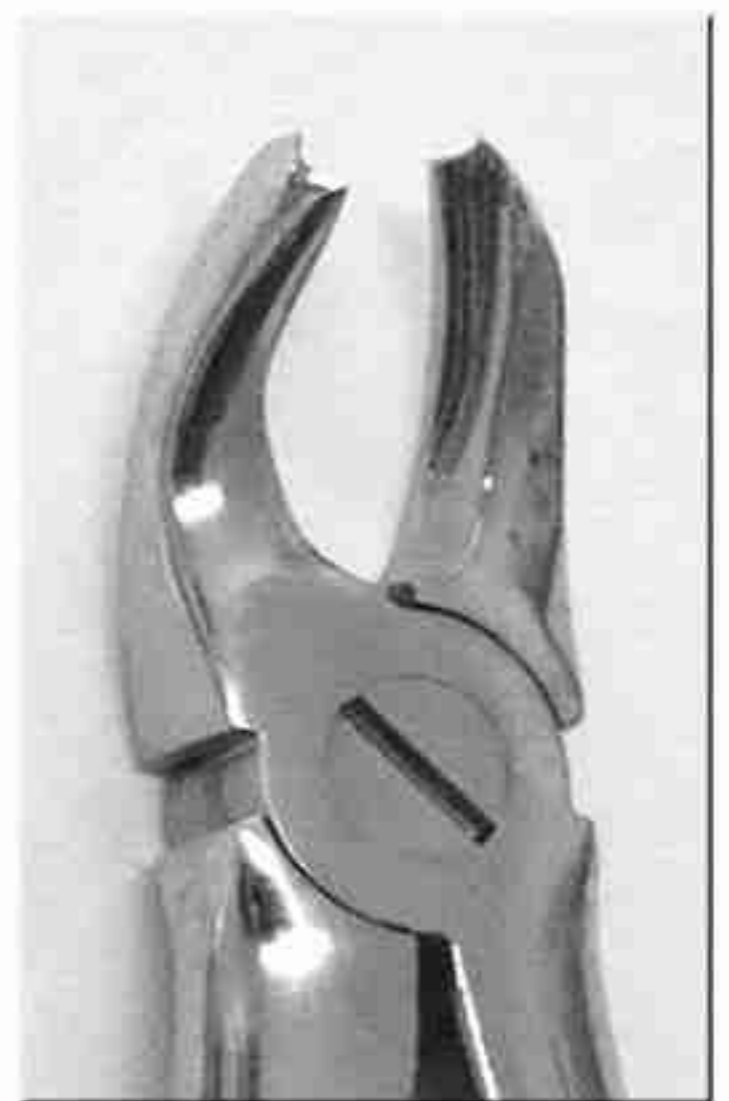

18 A

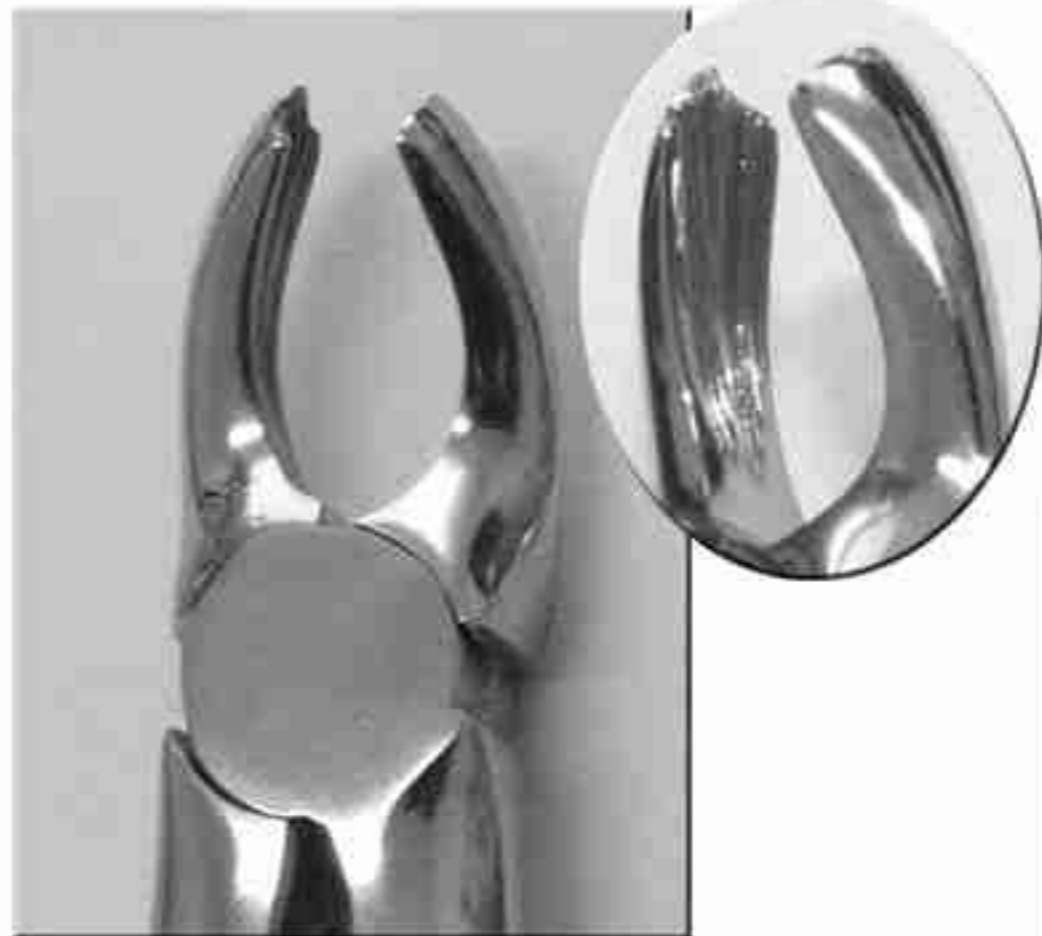

17



22



19



20



21

FOGHÚZÓ FOGÓK - ZAHNZANGE - EXTRACTING FORCEPS

DG 40/...



29

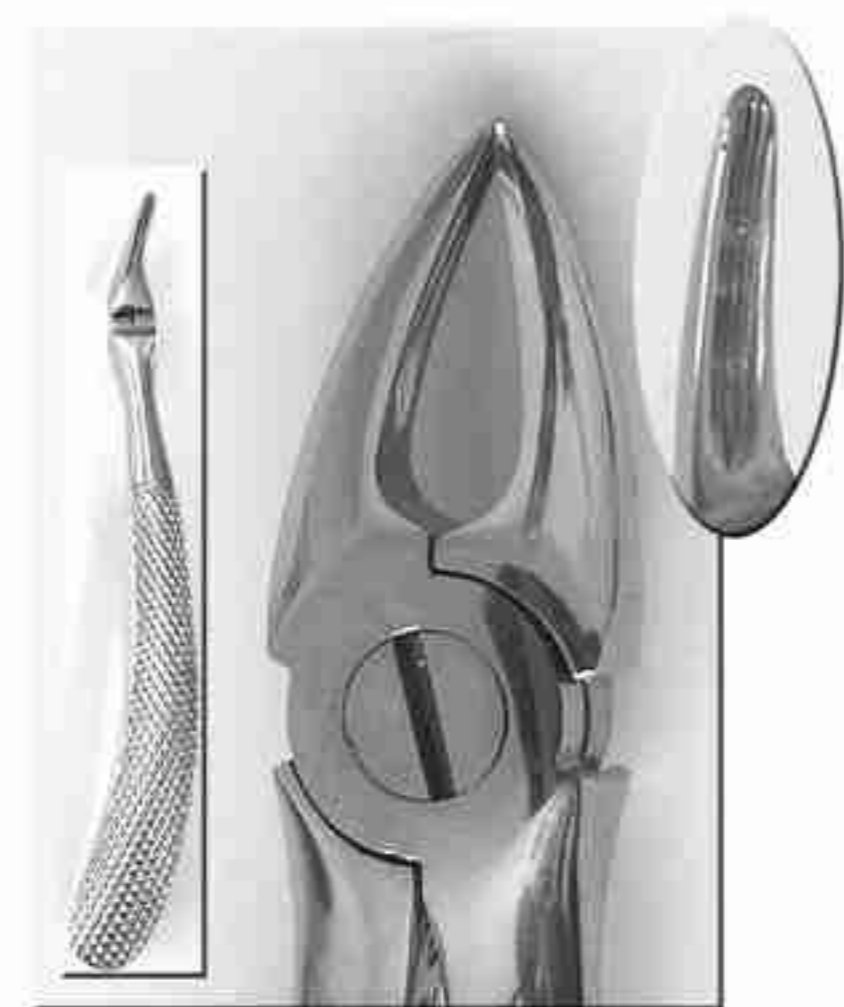

30



23



24



32

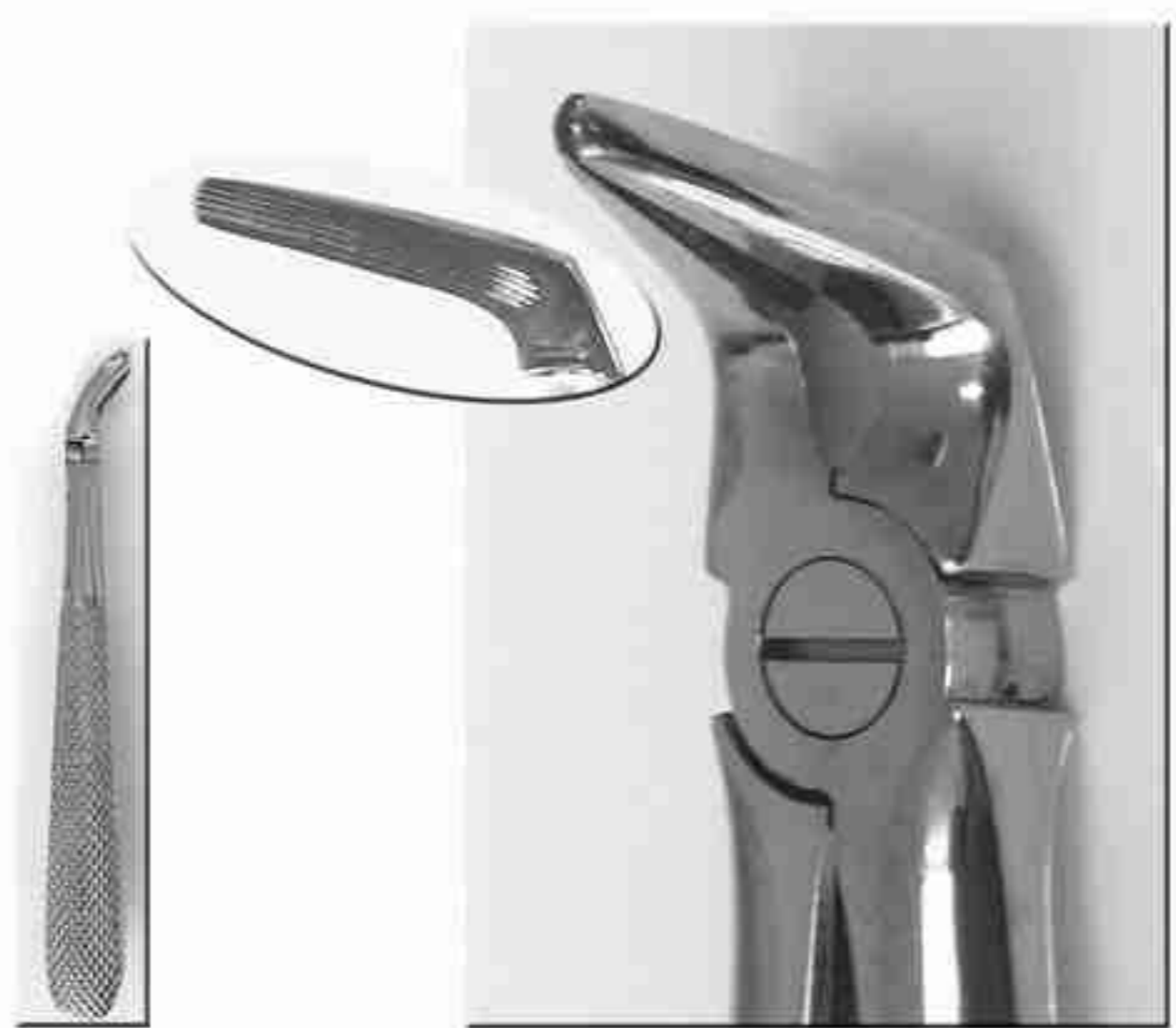

31

FOGHÚZÓ FOGÓK - ZAHNZANGE - EXTRACTING FORCEPS

DG 40/...



52 A



51 A



51



52



51 L

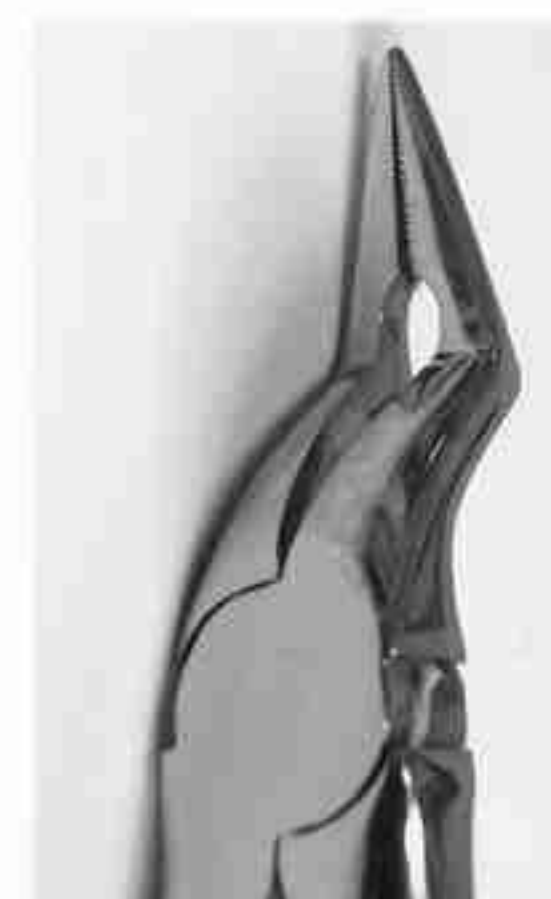

51 W



56

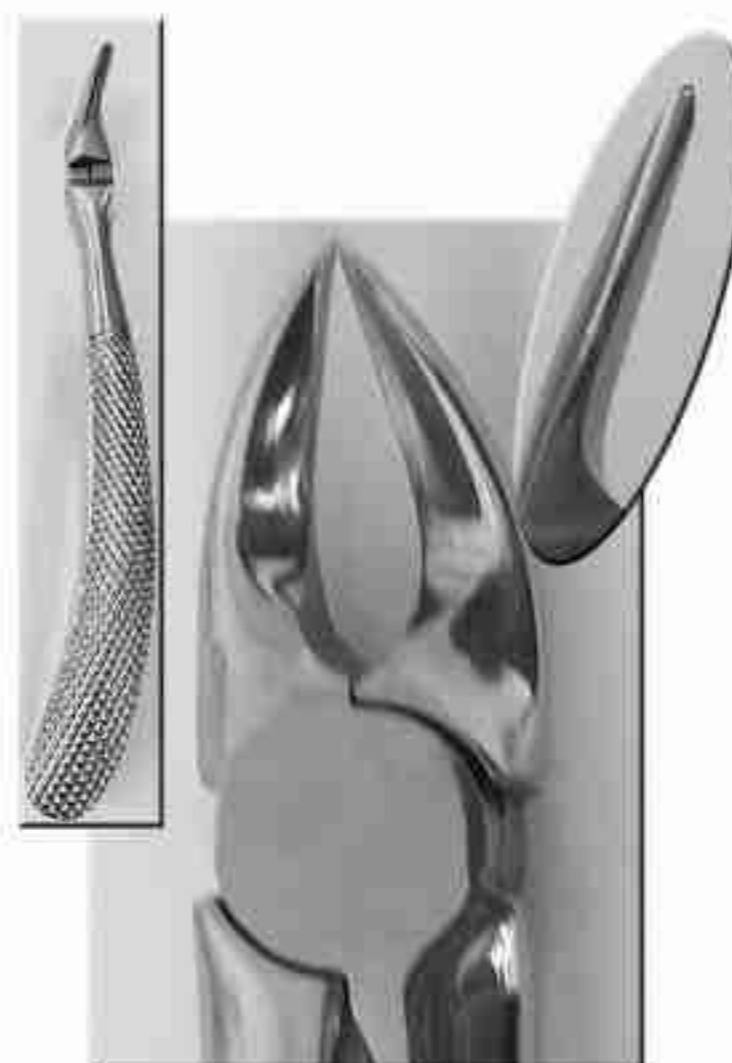

55



67

DG 40/...

FOGHÚZÓ FOGÓK - ZAHNZANGE - EXTRACTING FORCEPS



33

33 A

33 B



33 W



33 1/2



41



44



45



46 LX

INYLEVÁLASZTÓ
 ZAHNFLEISCHABTRENNER
 SPECIAL GUM KNIFE

DD 11



FOGHÚZÓ FOGÓK - ZAHNZANGE - EXTRACTING FORCEPS

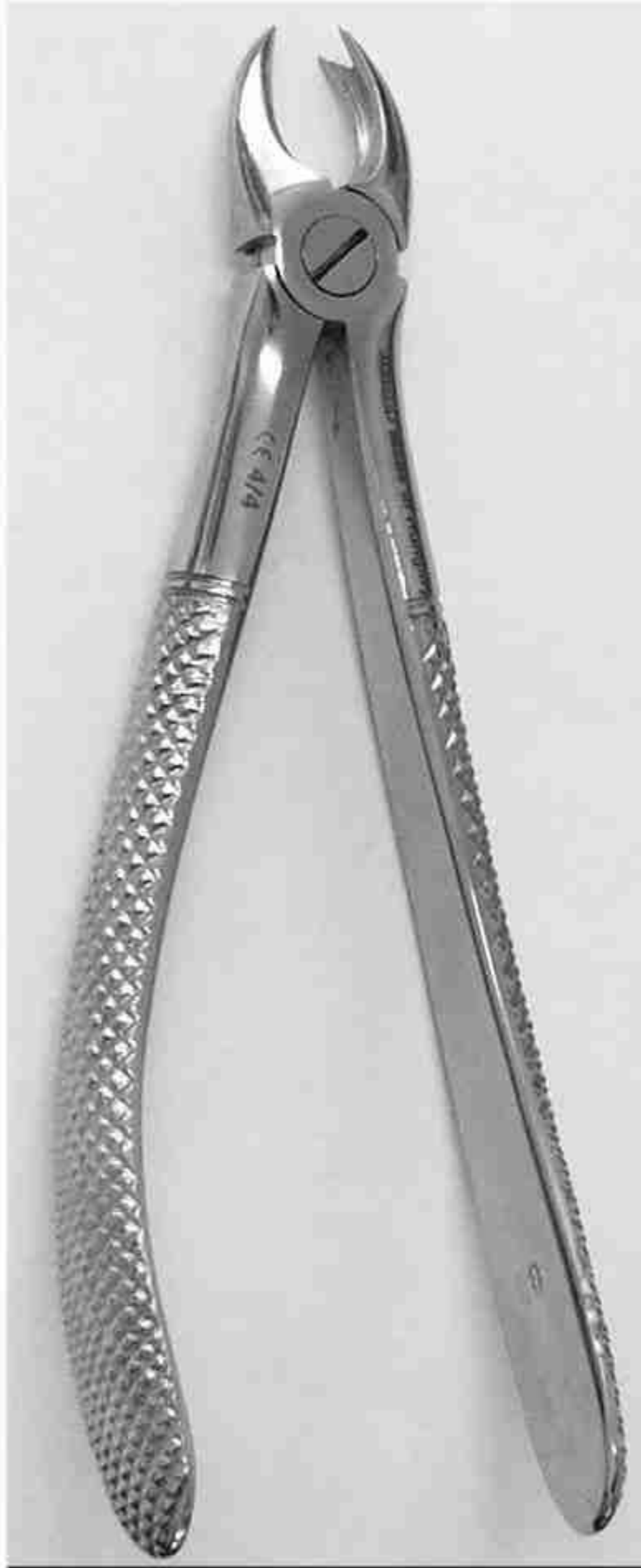

DG 40/...

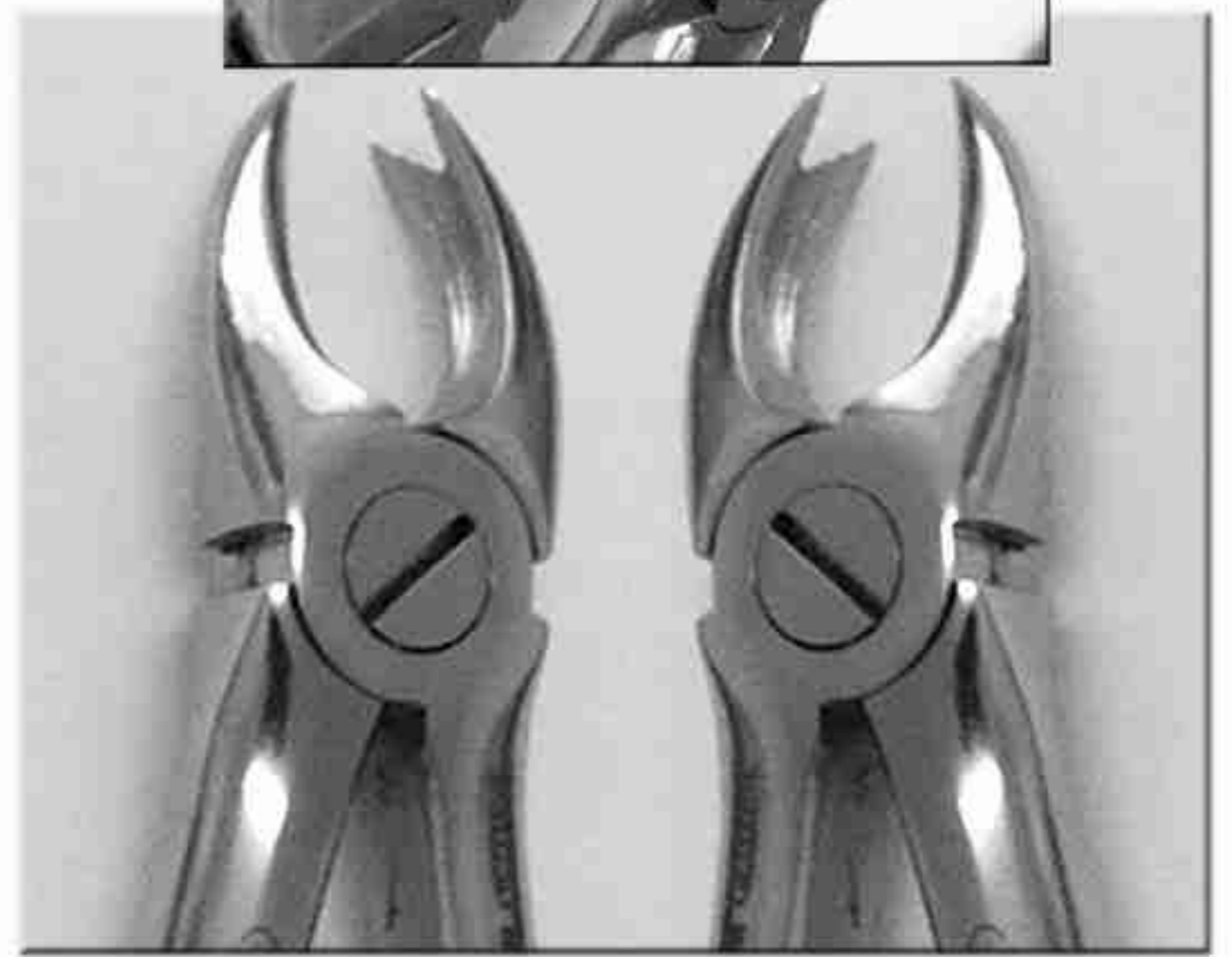

89

90



79

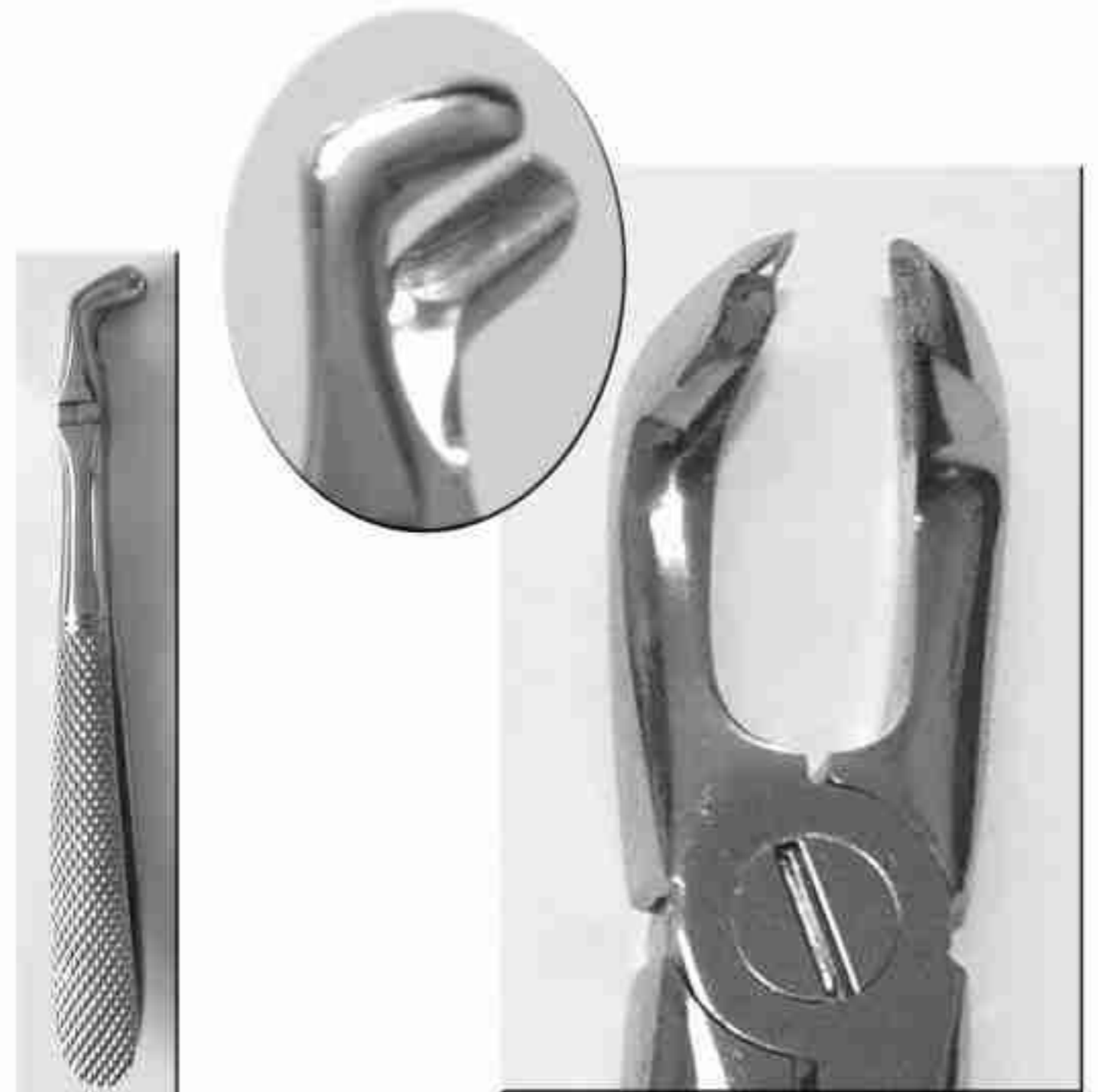

79 A

GYERMEK FOGHÚZÓ FOGÓK - KINDER ZAHNZANGE - EXTRACTING FORCEPS FOR CHILDREN

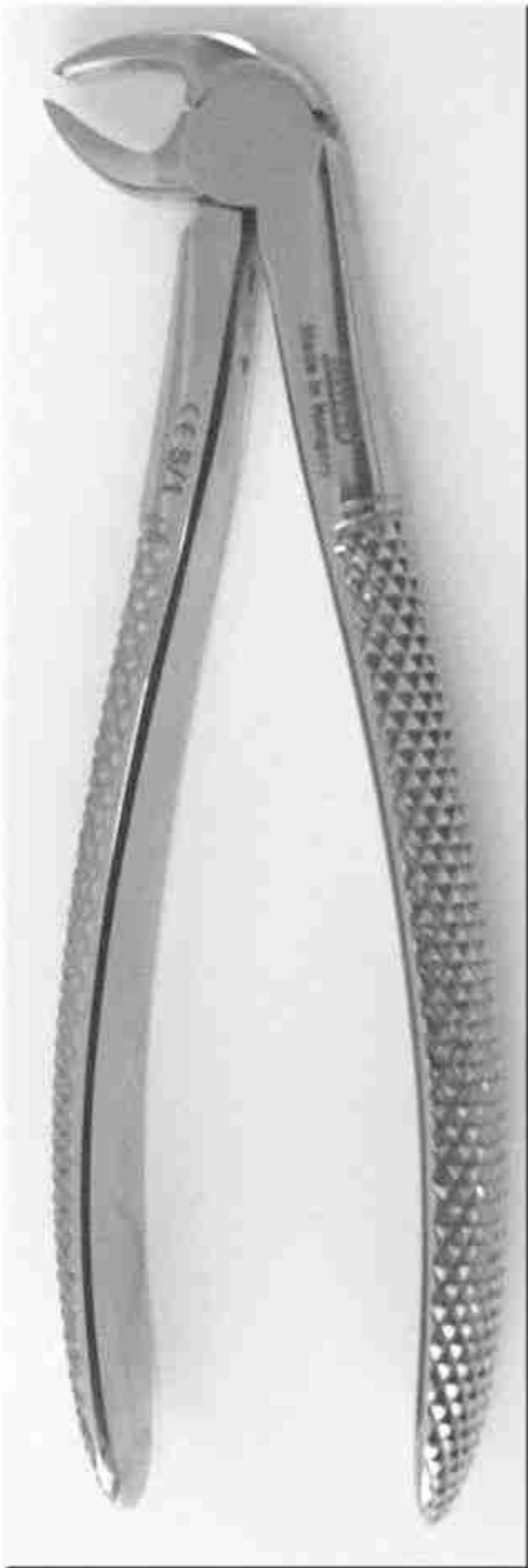

13 S



33 S



DG 40/...

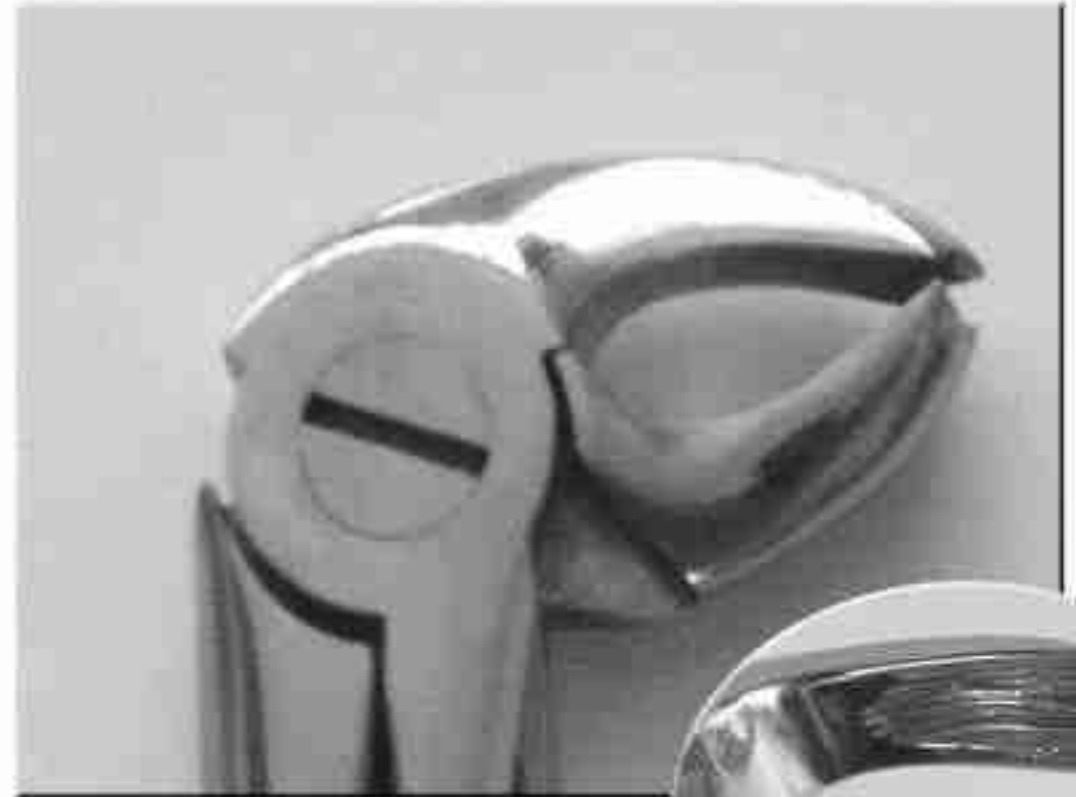

22 S

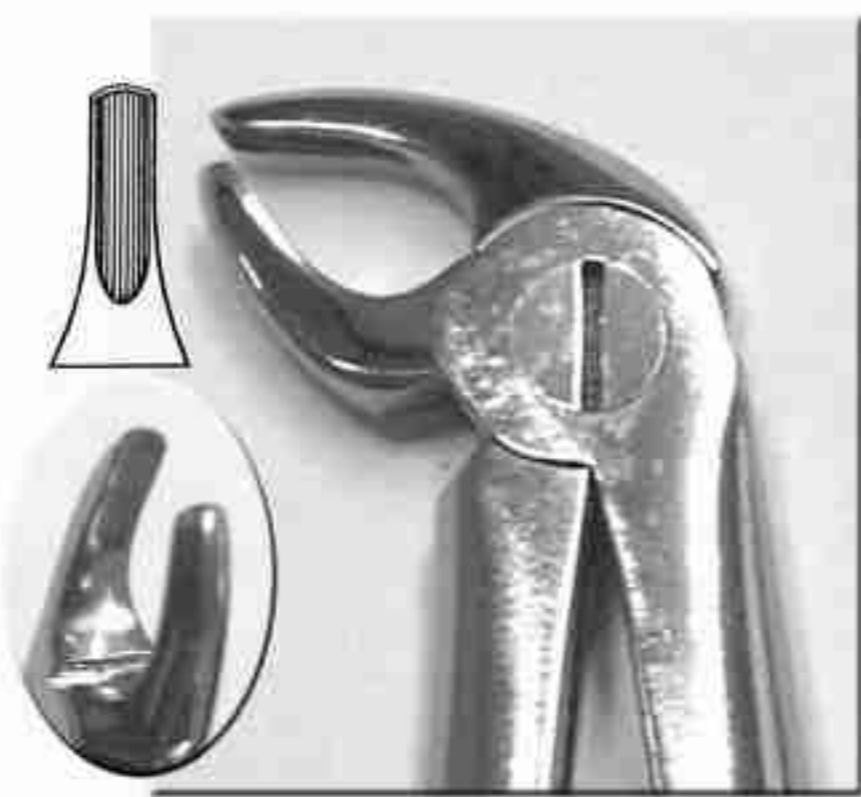

38



37

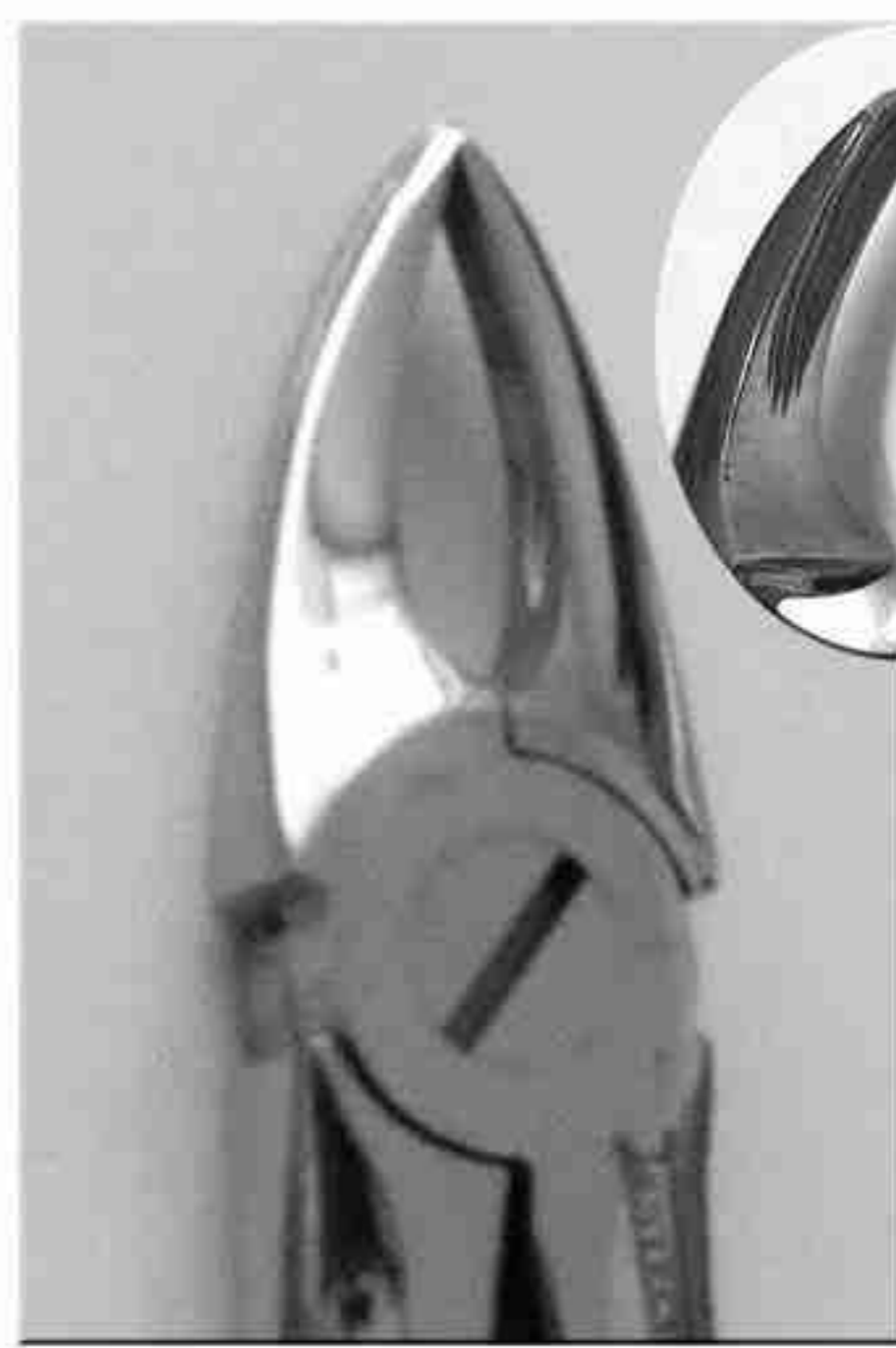

29 S

GYERMEK FOGHÚZÓ FOGÓK - KINDER ZAHNZANGE -
EXTRACTING FORCEPS FOR CHILDREN

DG 40/...

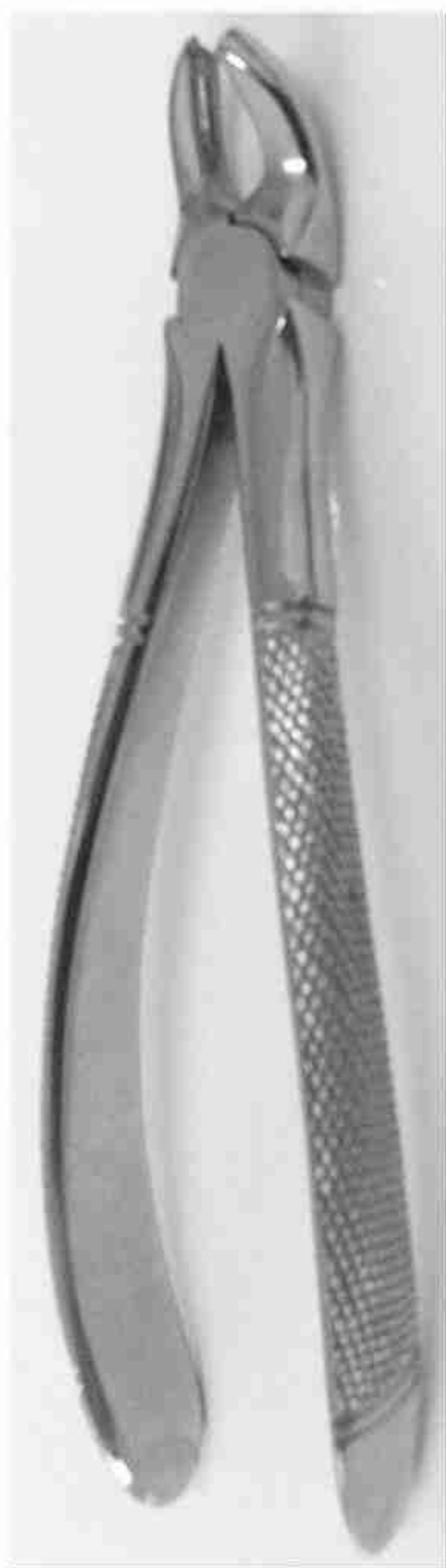

39 R

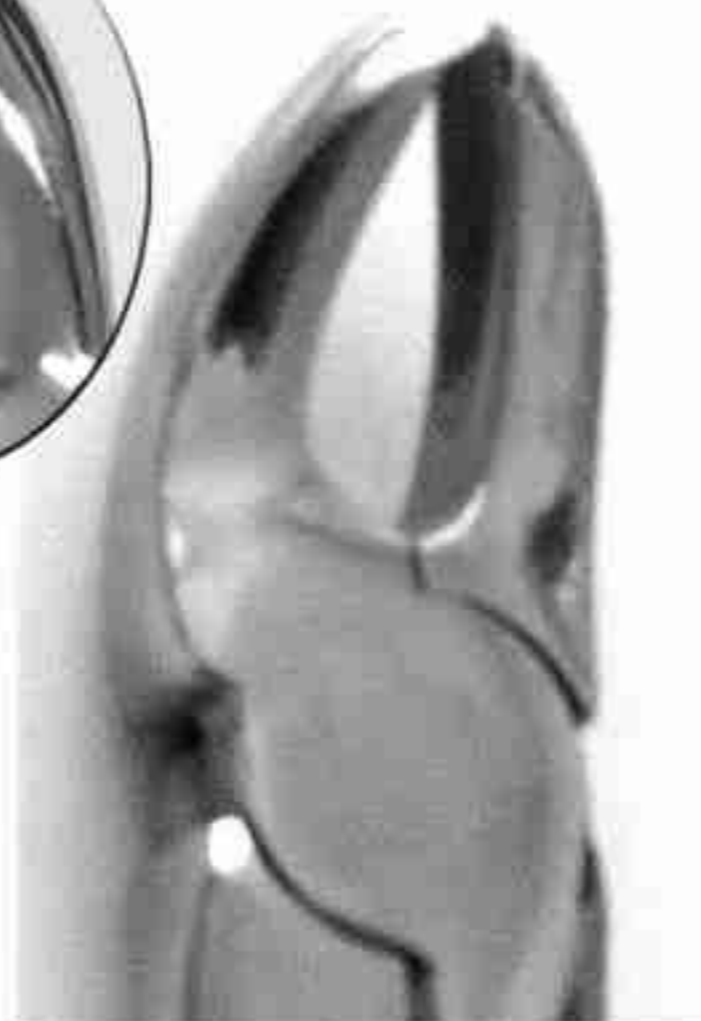

39 L

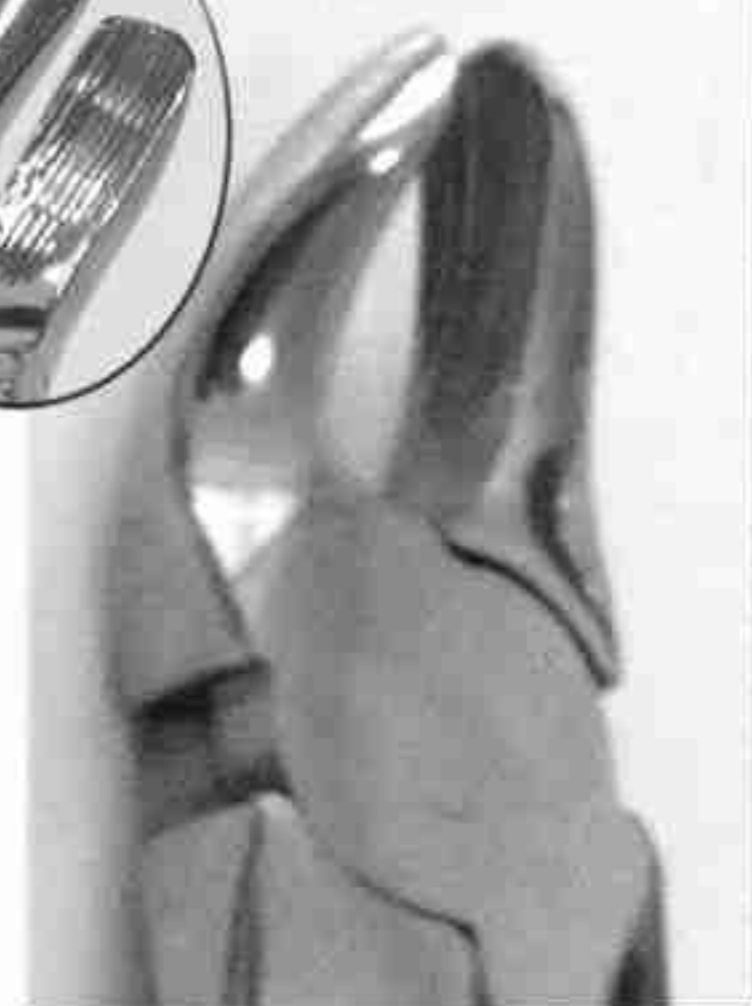

39

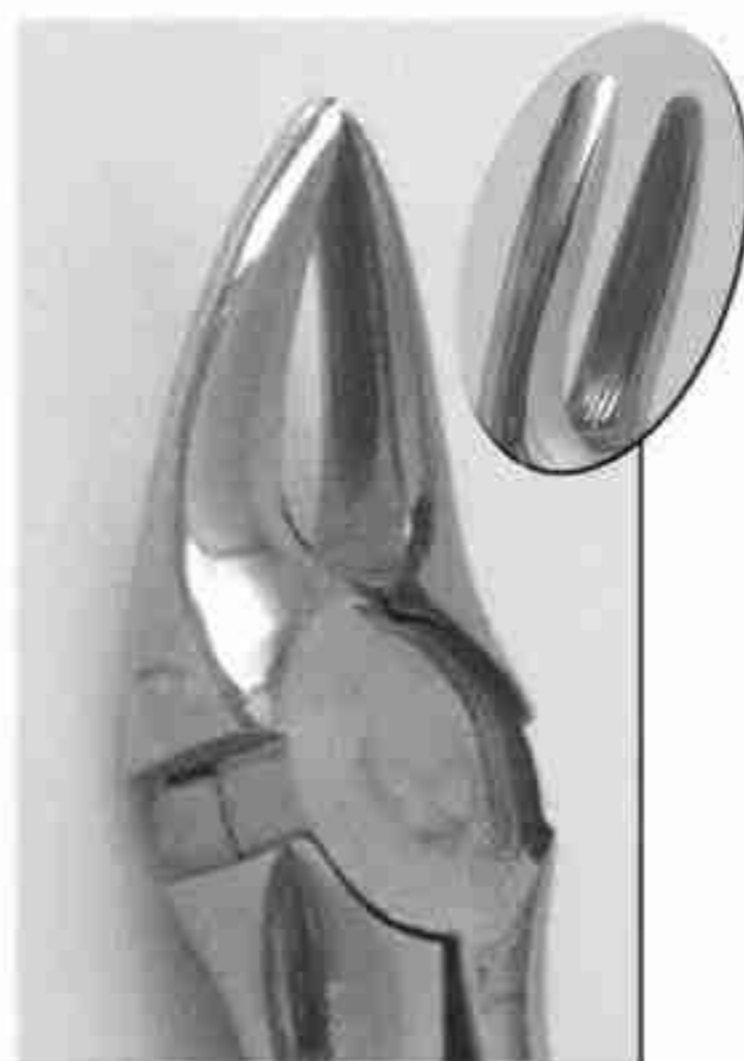

30 S

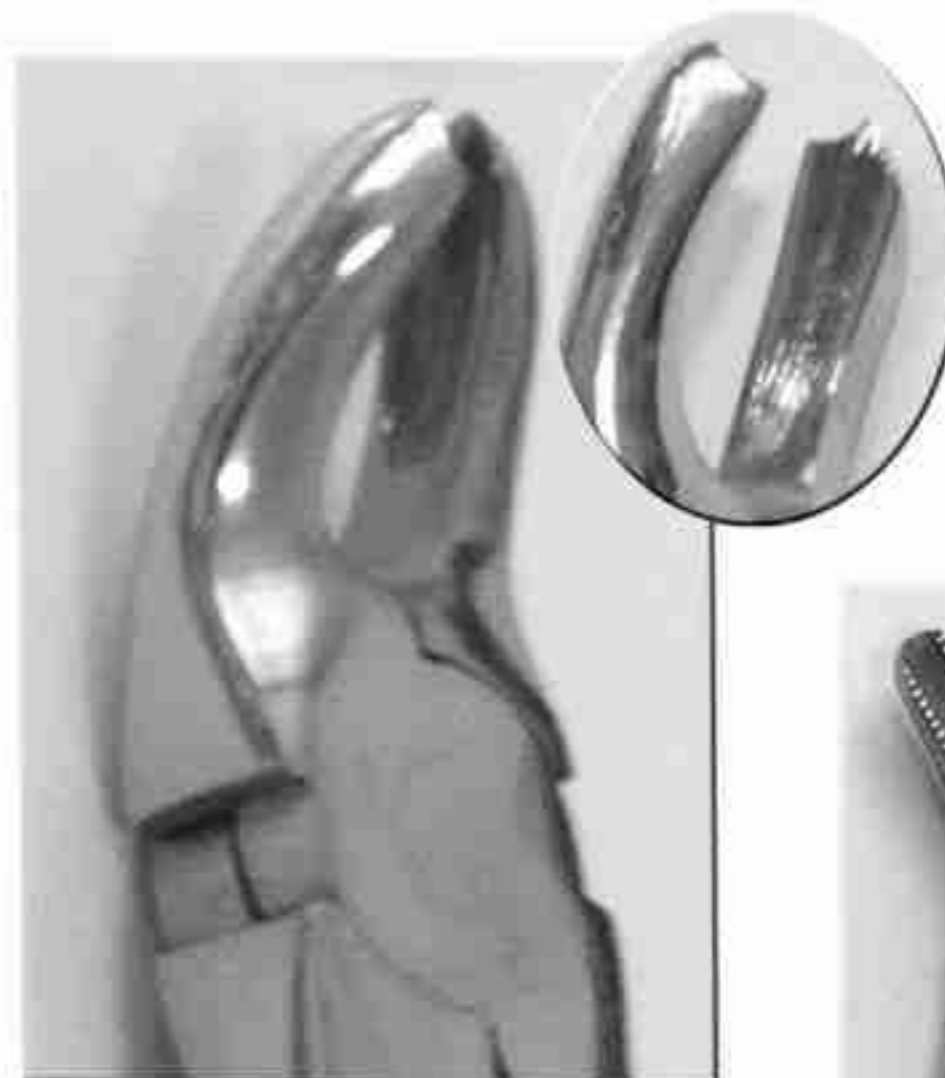

39 A



51 S

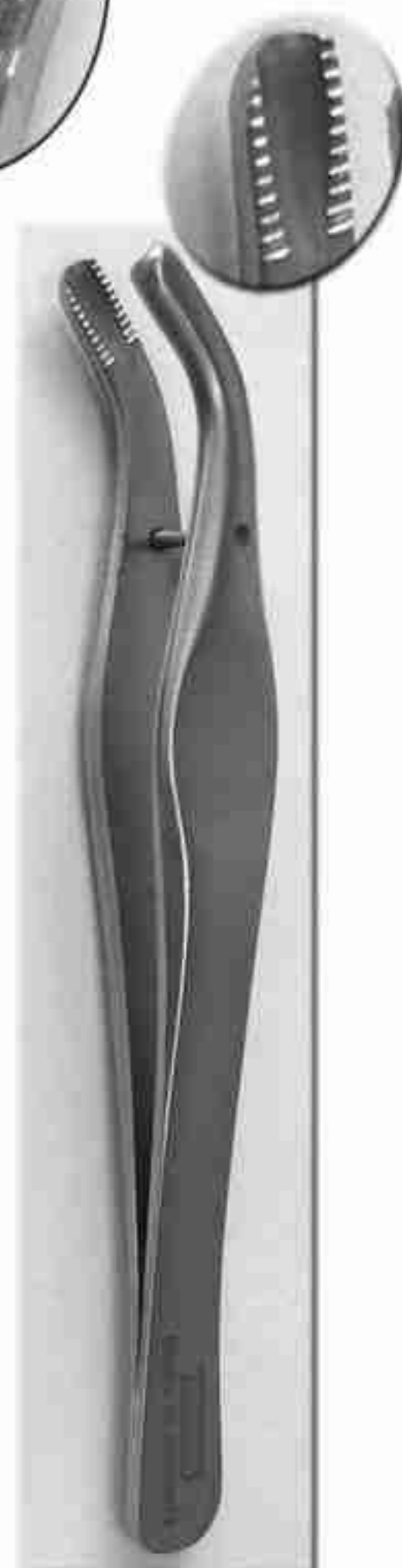

DG 40 / 100

TEJFOG CSIPESZ
MILCHZAHNPINZETTE
TWEezer FOR CHILDREN

GYERMEK FOGHÚZÓ FOGÓK - KINDER ZAHNZANGE -
KLEIN féle EXTRACTING FORCEPS FOR CHILDREN

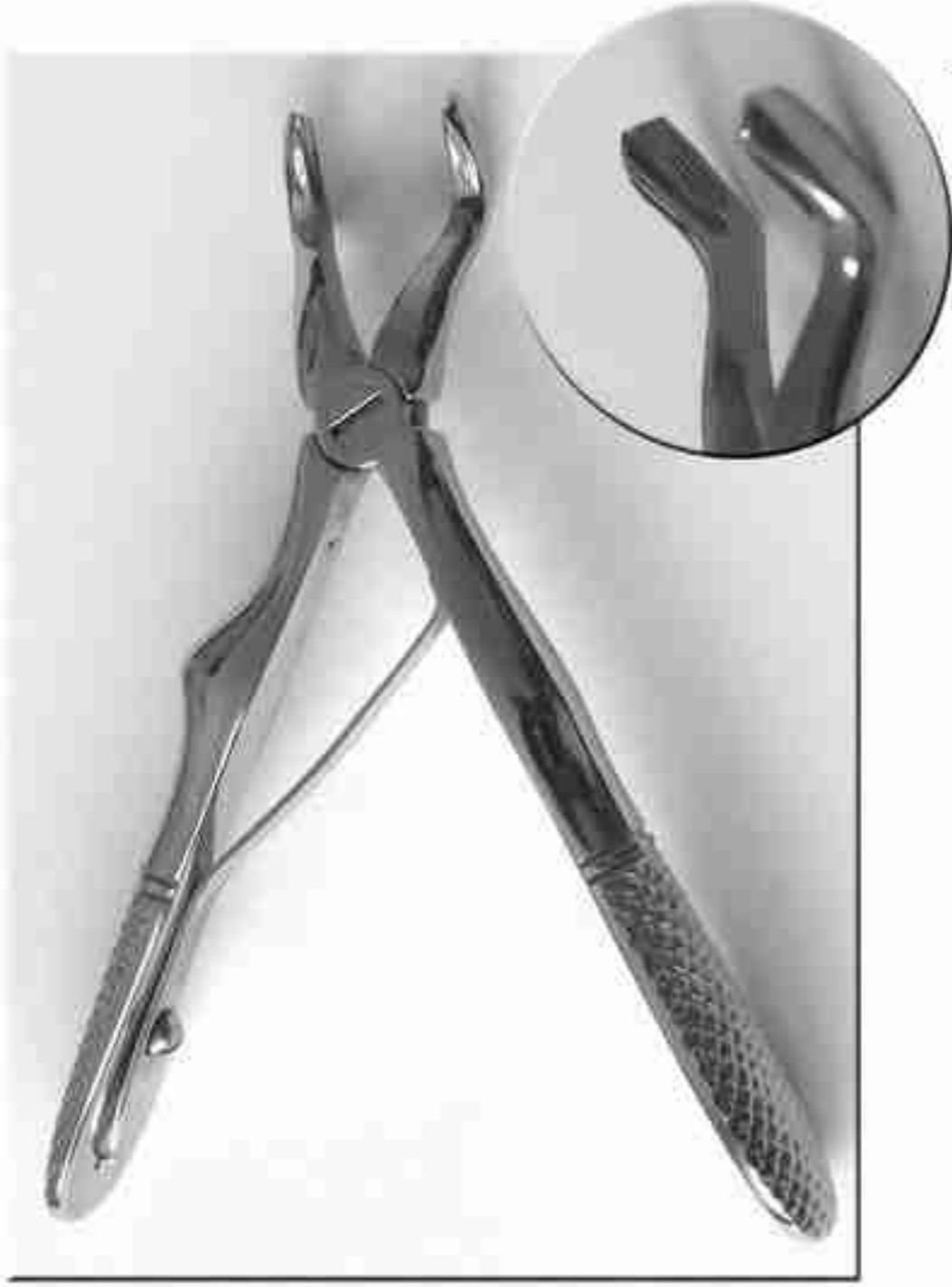

DK 901



DK 899



DK 897



DK 895



DK 910



DK 903



DK 905

GYÖKÉRSZILÁNK ELTÁVOLÍTÓ
WURZELSPITZENHEBER
ROOT TIP PICKS

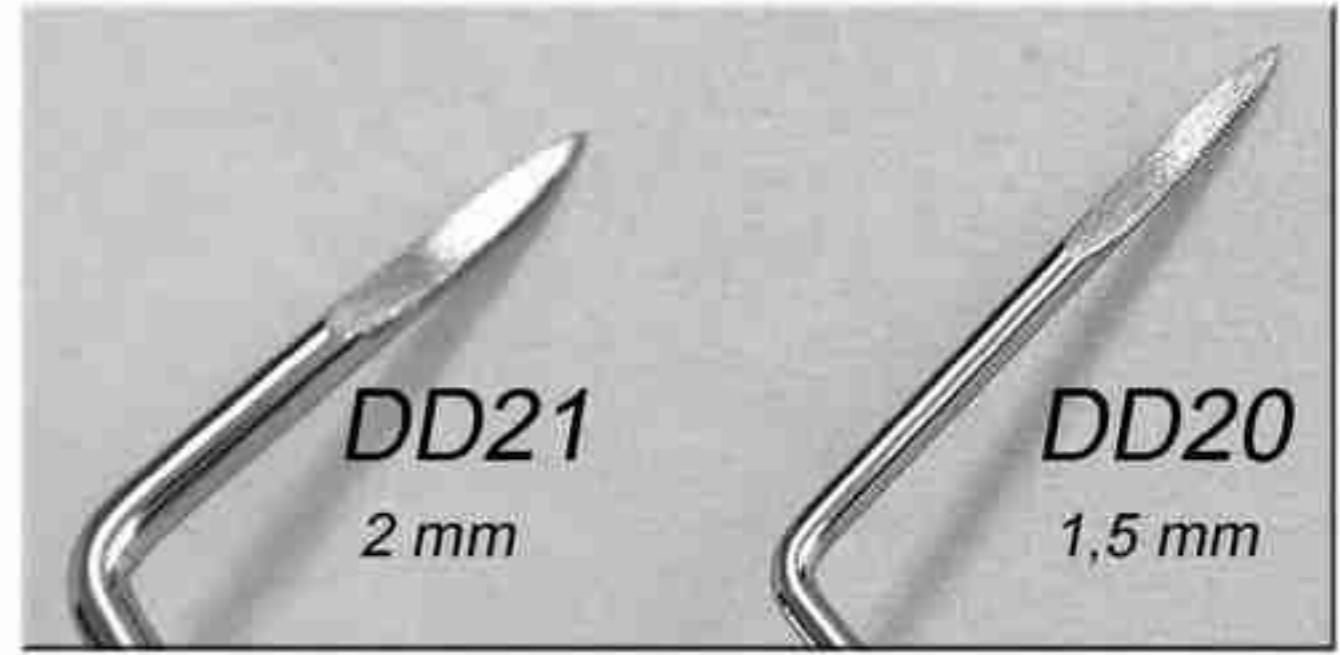

Luxator - Luxator -



LX 120



LX 125



LX 130



LX 135



LX 136



MT 180

180 gr

**FÉM KALAPÁCS TEFLONBETÉTEL
HAMMER MIT TEFLON EINSATZ
MALLETS WITH TEFLON INSERT**

MT 110

110 gr



MS 180

180 gr

**FÉM KALAPÁCS
HAMMER AUS METALL
MALLETS STAINLES STEEL**

MS 110

110 gr

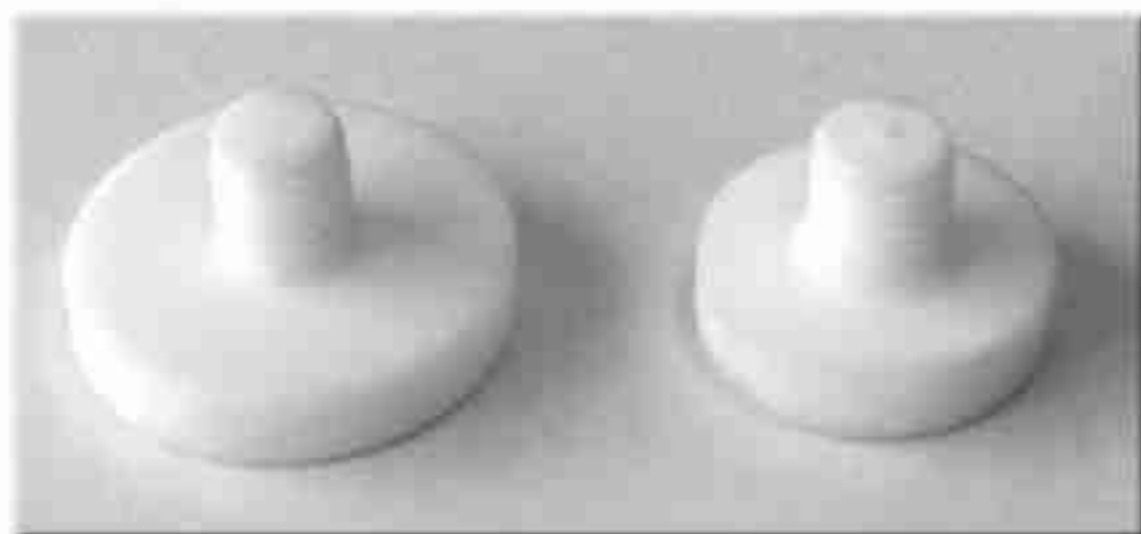

**TEFLONBETÉT
TEFLON EINSATZ
TEFLON INSERT**

MT 111 d=20 mm

MT 181 d=25 mm

LAPOS VÉSŐK -

FLACHMEISSEL -

BONE CHISELS AND GOUGES



- FL 1183 3 x 2 mm
- FL 1184 4 x 2,5 mm
- FL 1185 5 x 3 mm
- FL 1186 6 x 3 mm

Partsch
17 cm



- FL 1173 3 x 2 mm
- FL 1174 4 x 2,5 mm
- FL 1175 5 x 2,4 mm
- FL 1176 6 x 2,6 mm

Partsch
14 cm



- | | |
|------------------|---------|
| FL 1101 4 x 2,3 | FL 1111 |
| FL 1102 6 x 2,3 | FL 1112 |
| FL 1104 8 x 2,3 | FL 1114 |
| FL 1106 10 x 2,3 | FL 1116 |

Lambotte
12 cm



- DD2 2 mm
- DD3 3 x 2,2 mm
- DD4 4 x 2,4 mm
- DD5 5 x 2,6 mm
- DD6 6 x 2,8 mm

Móczár
15 cm



17 cm

- FL 1223
- FL 1224
- FL 1225
- FL 1226

VÁJT VÉSŐ
HOHLMEISSEL
GOUGES

- 3 mm
- 4 mm
- 5 mm
- 6 mm

14 cm

- FL 1213
- FL 1214
- FL 1215
- FL 1216



FL 1124 4mm
FL 1126 6mm

BAJONETT VÉSŐ
MEISSEL
BAJONETT-FÖRMIG
BONE -CHISELS
BAYONET-SHAPED



DP 1780
KORONA ELTÁVOLÍTÓ
" SZTRILICH "
KRONENABNEHMER MIT
FEDERN " SZTRILICH "
CROWN REMOVERS

DP 1781/5 195 mm
BOWDEN HOSSZÚ
DP 1781-HEZ
SCHLINGE LANG
FÜR DP 1781
LOOP LONG
FOR DP 1781

FEJ DP 1781-HEZ
KOPF FÜR DP 1781
HEAD FOR DP 1781

DP 1781/3-1 **DP 1781/3-2** **DP 1781/3-3**



DP 1781
UNIVERZÁLIS KORONAELTÁVOLÍTÓ
UNIVERSAL KRONENENTFERNER
UNIVERSAL CROWN REMOVER

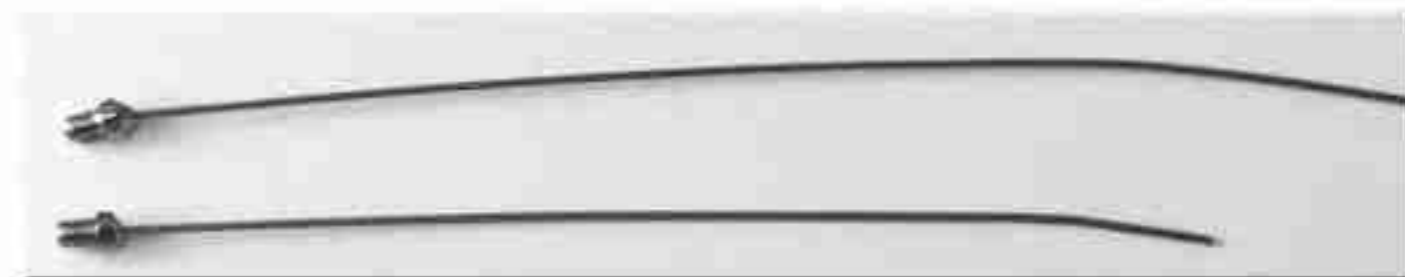

DP 1781/4 85 mm
BOWDEN RÖVID
DP 1781-HEZ
SCHLINGE KURZ
FÜR DP 1781
LOOP SHORT
FOR DP 1781



DP 1781/2
DUPLA HUOKRENDSZER
A DP 1781-HEZ
DOPPELSCHLAUFENSYSTEM
FÜR DP 1781
DOUBLE LOOP TIP FOR DP 1781



DP 1781/1
EGYSZERES HUOKRENDSZER
DP 1781-HEZ
EINZELSCHLAUFENSYSTEM
FÜR DP 1781
SIMPLE LOOP TIP FOR DP 1781



DP1783
KORONAFELTÁRÓ, OLLÓS
KRONENABNEHMER-SCHERE
CROWN REMOVERS SCISSORS



DP 1784
KORONAFELTÁRÓ
KRONENENABNEHMER
CROWN REMOVER



KORONAFELTÁRÓ 6db BETÉTTTEL
KRONENENTFERNER MIT 6 EINSATZEN
CROWN REMOVERS WITH 6 INSERT



DP 1782
KÉTVÉGŰ KORONAFELTÁRÓ
KRONENABNEHMER ZWEISPITZIG
CROWN REMOVER DOUBLE ENDED



DF 1760
VESETÁL 20 cm
NIERENSCHALE
KIDNEY DISHES



DF 1761 /...

MŰSZERTÁLCÁK	1	(19 X 10 X 1,5 cm)
INSTRUMENT TABLETTEN	2	(20 X 10 X 1 cm)
INSTRUMENT TRAYS	3	(20 X 15 X 1 cm)

DF 1762 PEREMES MŰSZERTÁLCÁK 32X22X2 Cm
INSTRUMENT TABLETTEN MIT RAND
INSTRUMENT TRAY WITH COLLAR

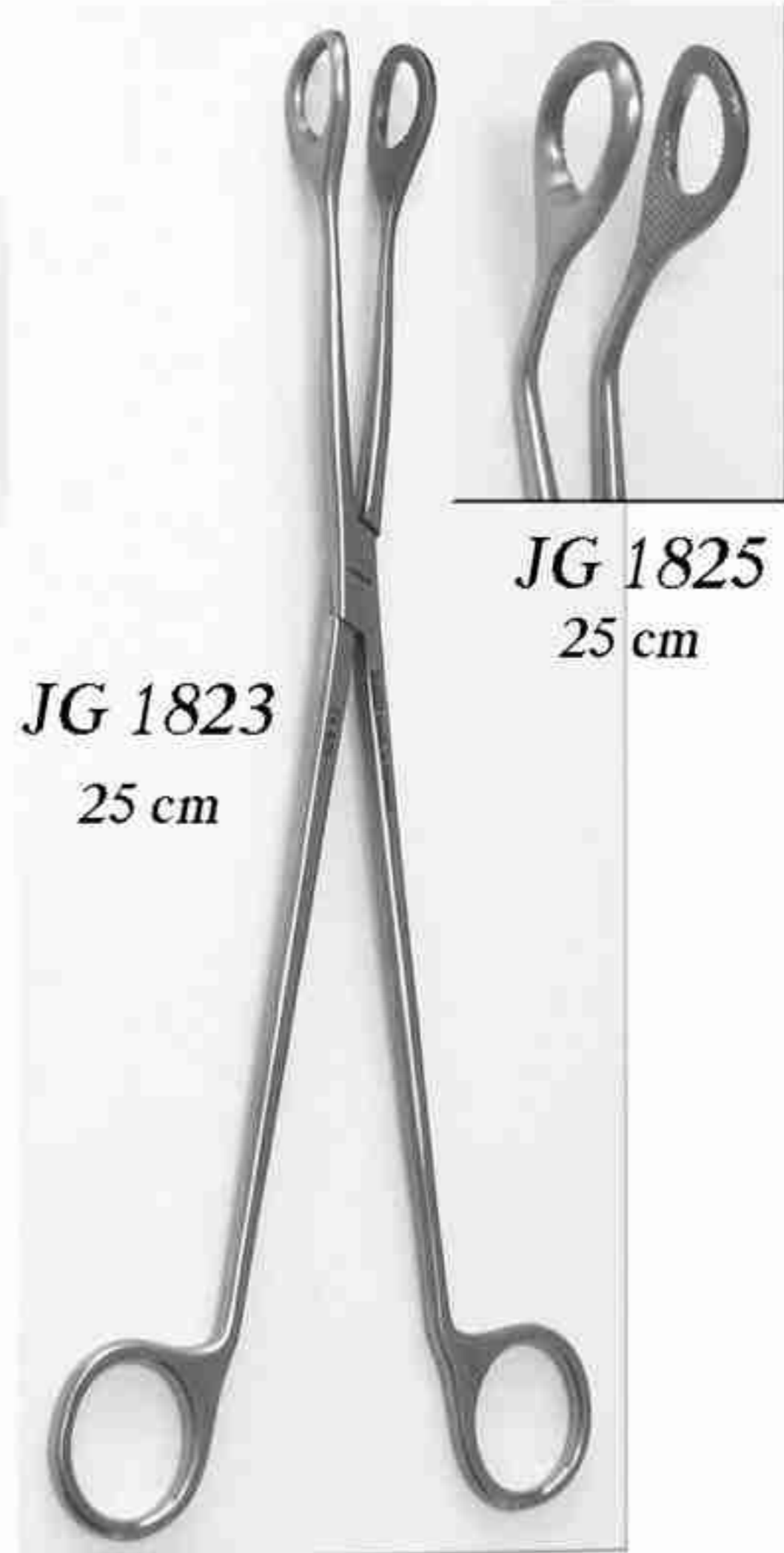

JG 1823
 25 cm

JG 1825
 25 cm

STERILIZÁLÓ-

MŰSZERKISZEDŐ FOGÓK
STERILISIERZANGE
STERILIZING FORCEPS

MŰSZERTÁROLÓ DOBOZ
INSTRUMENTEN BEHALTER
INTRUMENTS BOXES

- DF 066 (17x7x3 cm)
- DF 067 (17,5x7,5x3 cm)
- DF 068 (18x6x3 cm)
- DF 069 (18x7x3 cm)
- DF 070 (18x9x4 cm)
- DF 071 (20x10x4 cm)
- DF 072 (21x10x4 cm)
- DF 073 (25x12x5 cm)

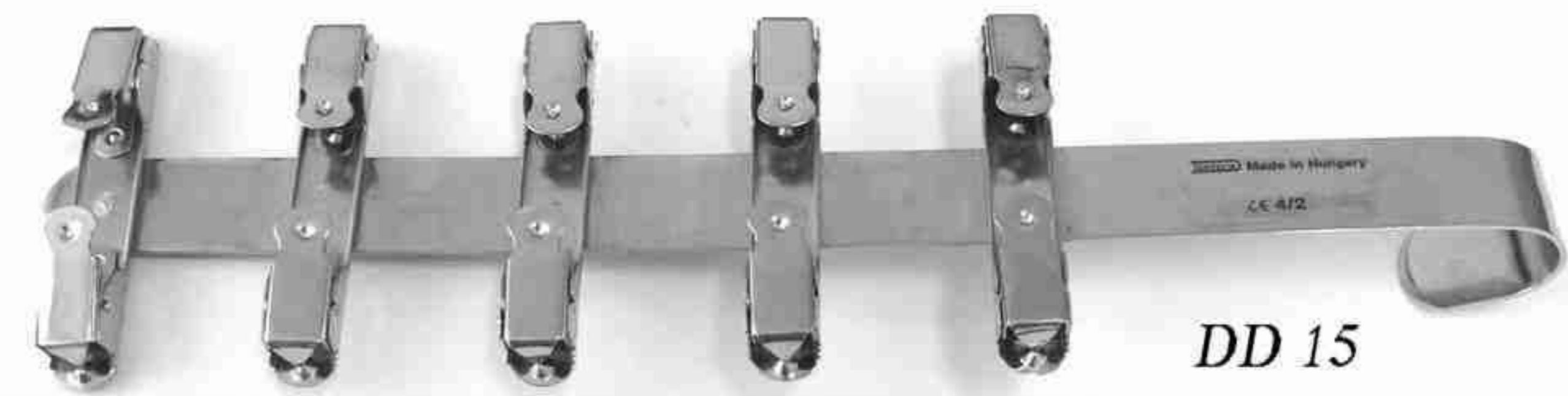

DD 15

RÖNTGENFILMLÉTRA
FILMLEISTE
X-RAY FILM HOLDER

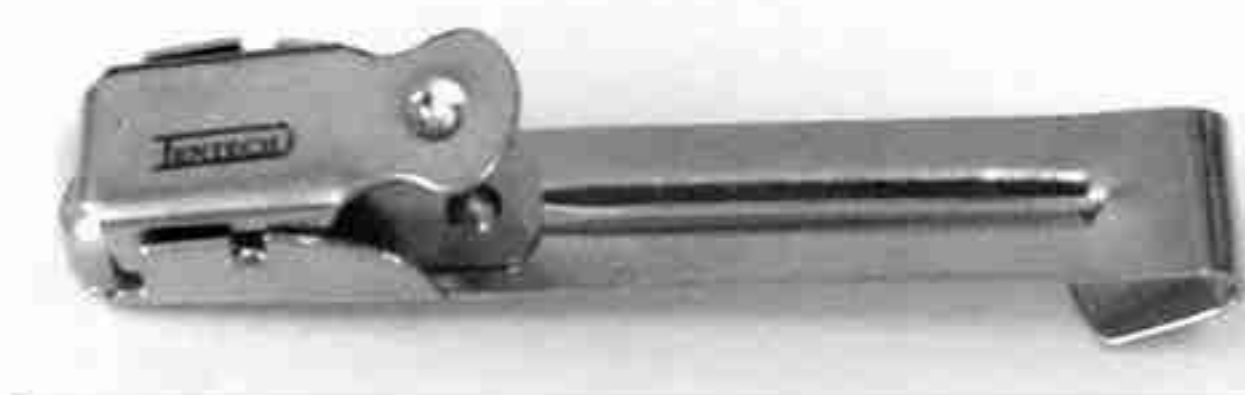

DD 16
RÖNTGENFILM CSIPESZ
RÖNTGENFILM PINZETTE
X-RAY FILM CLIP



DD 17

FOGFILM TARTÓ FERENCZI-FÉLE
ZAHNFILMHALTER FERENCZI
DENTAL FILM HOLDER FERENCZI



DF 1750

ASZTALI VATTATARTÓ , FÉM
WATTEBEHALTER , METALL
COTTON WOOL HOLDER



DF 1751

BORSZESZÉGŐ
SPIRITUSLAMPE
ALCOHOL BURNER

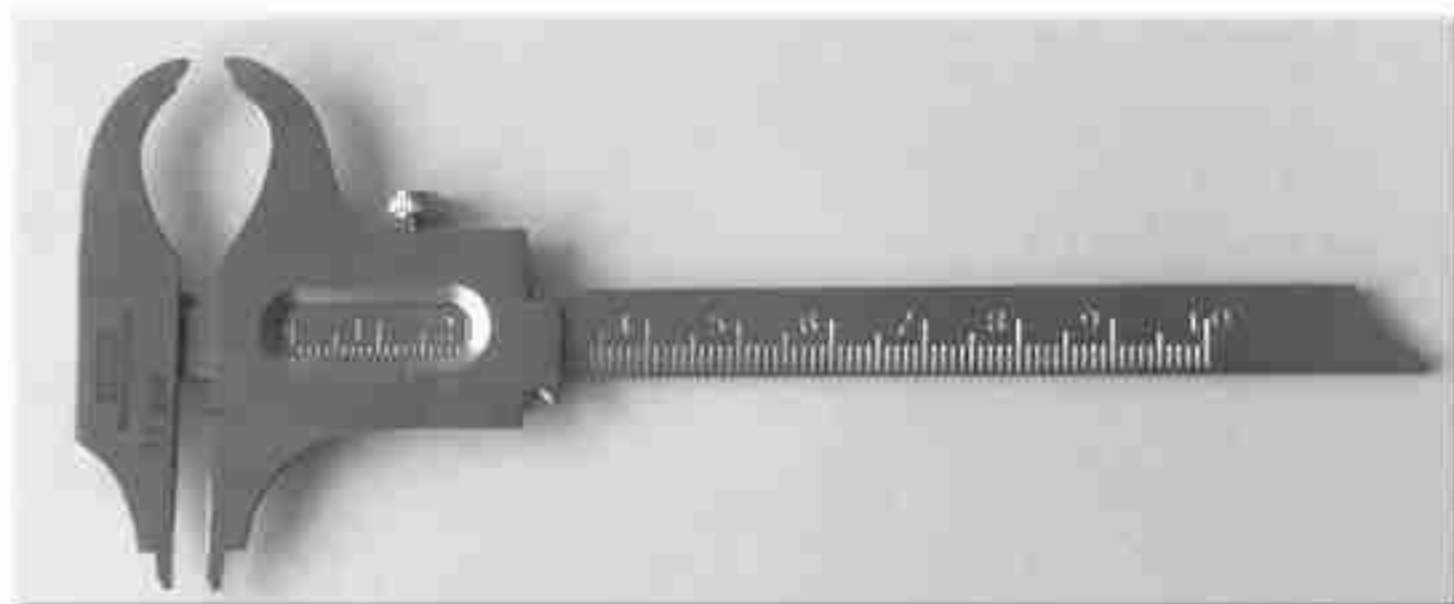

**MI 101**

BOLEY TOLÓMÉRŐS CSONTVASTAGSÁGMÉRŐ
BOLEY SCHIEBLEHRE
BOLEY BONE MEASURING INSTRUMENT

**MI 102**

BEERENDONK TOLÓMÉRŐS
CSONTVASTAGSÁGMÉRŐ
BEERENDONK SCHIEBLEHRE
BEERENDONK BONE MEASURING INSTRUMENT

**MI 103**

CSONTVASTAGSÁGMÉRŐ GYŰRŰS
KNOCHEN MEBZIRKEL
BONE MEASURING INSTRUMENT
 13 cm

**MI 104**

CASTROVIEJO CSONTVASTAGSÁGMÉRŐ
CASTROVIEJO KNOCHEN MEBZIRKEL
CASTROVIEJO BONE MEASURING INSTRUMENT
 9 cm

IMPLANTOLÓGIAI SZETT
 SET FÜR IMPLANTOLOGIE
 IMPLANTOLOGY SET

KI 100

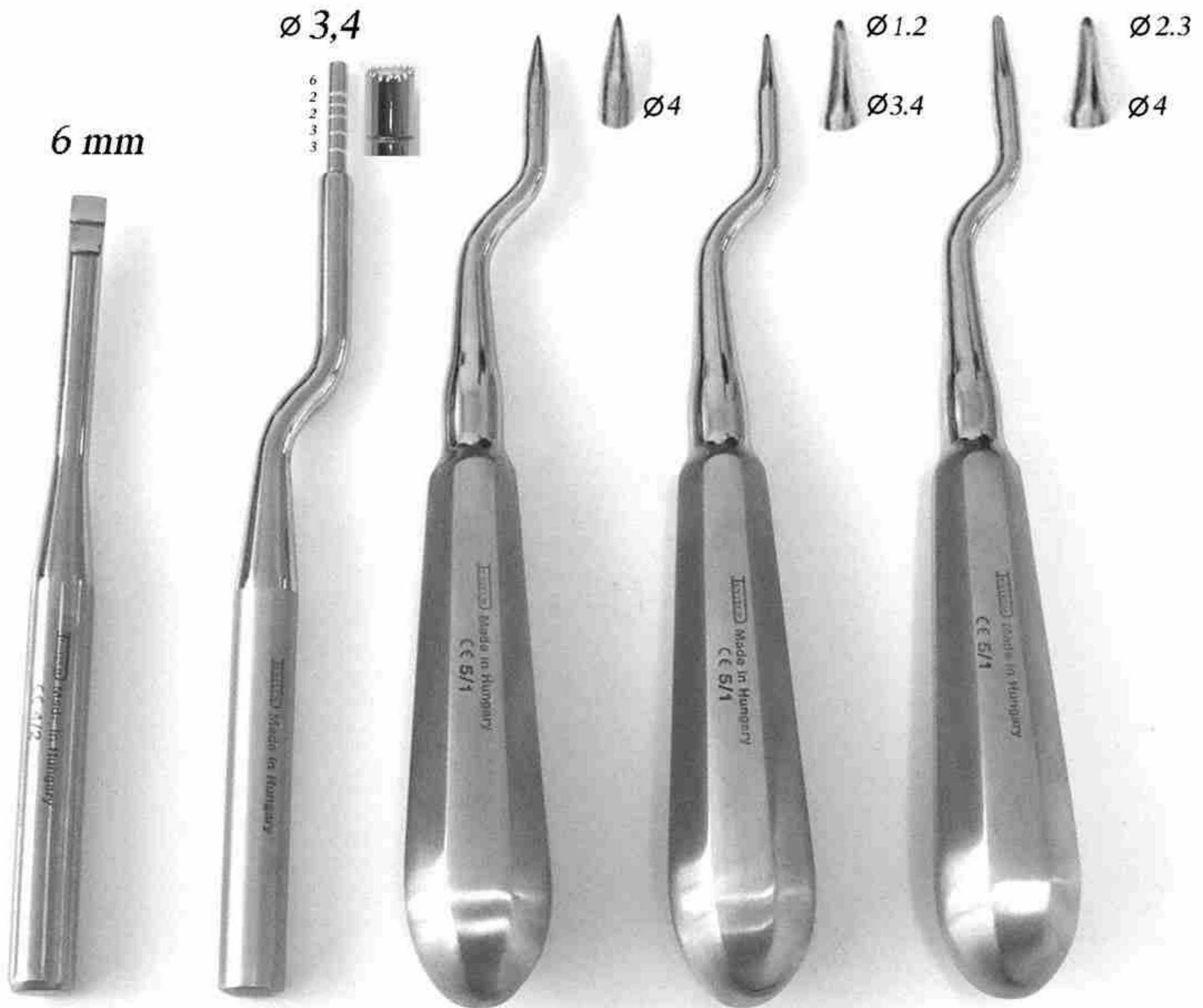

VI 101

BI 100

TI 100

TI 101

TI 102



TP 100
 TITÁN CSIPESZ
 TITAN PINZETTE
 TITAN FORCEPS
 14.5 cm

SINUS RASPATORIM
 SINUS RASPATORIUM
 SINUS RASPATORY

RI 100 4 mm
 RI 101 6 mm





CSONTTÖMÖRÍTŐ CT
 OSTEOTOM BAJONETT
 OSTEOTOM BAYONET

6 mm
 2 mm
 2 mm
 3 mm
 3 mm



SINUSBEÚTÓ SB
 SINUTOM BAJONETT
 SINUTOME BAYONET

6 mm
 2 mm
 2 mm
 3 mm
 3 mm

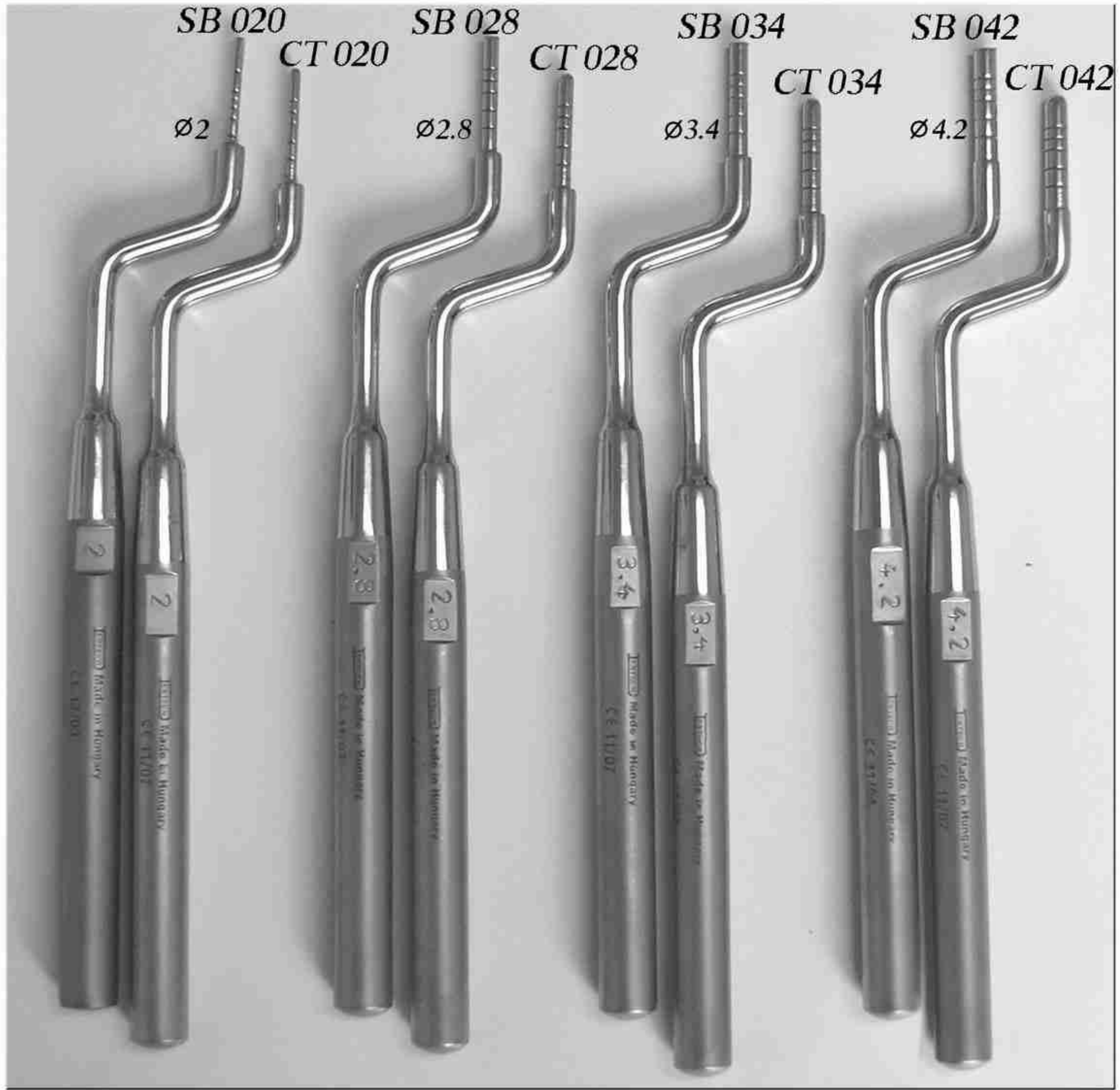

SB 020 CT 020 SB 028 CT 028 SB 034 CT 034 SB 042 CT 042

Ø2 Ø2.8 Ø3.4 Ø4.2

2 2.8 3.4 4.2

TENTECH Made in Hungary
 CE 11/01 CE 11/01 CE 11/01 CE 11/01



SINUS BEÜTŐ ÜTKÖZŐVEL
 SINUTOM MIT STOPPER
 SINUTOME WITH STOPPER

- SB120 Ø 2 MM
- SB128 Ø 2,8 MM
- SB134 Ø 3,4 MM
- SB142 Ø 4,2 MM



OSTEOTOM ÜTKÖZŐVEL
 OSTEOTOM MIT STOPPER
 OSTEOTOME WITH STOPPER

- CT120 Ø 2 MM
- CT128 Ø 2,8 MM
- CT134 Ø 3,4 ,MM
- CT142 Ø 4,2 MM

58.



Titan

CD1000
CSONTDARÁLÓ
KNOCHENMÜHLE
BONE-MILL

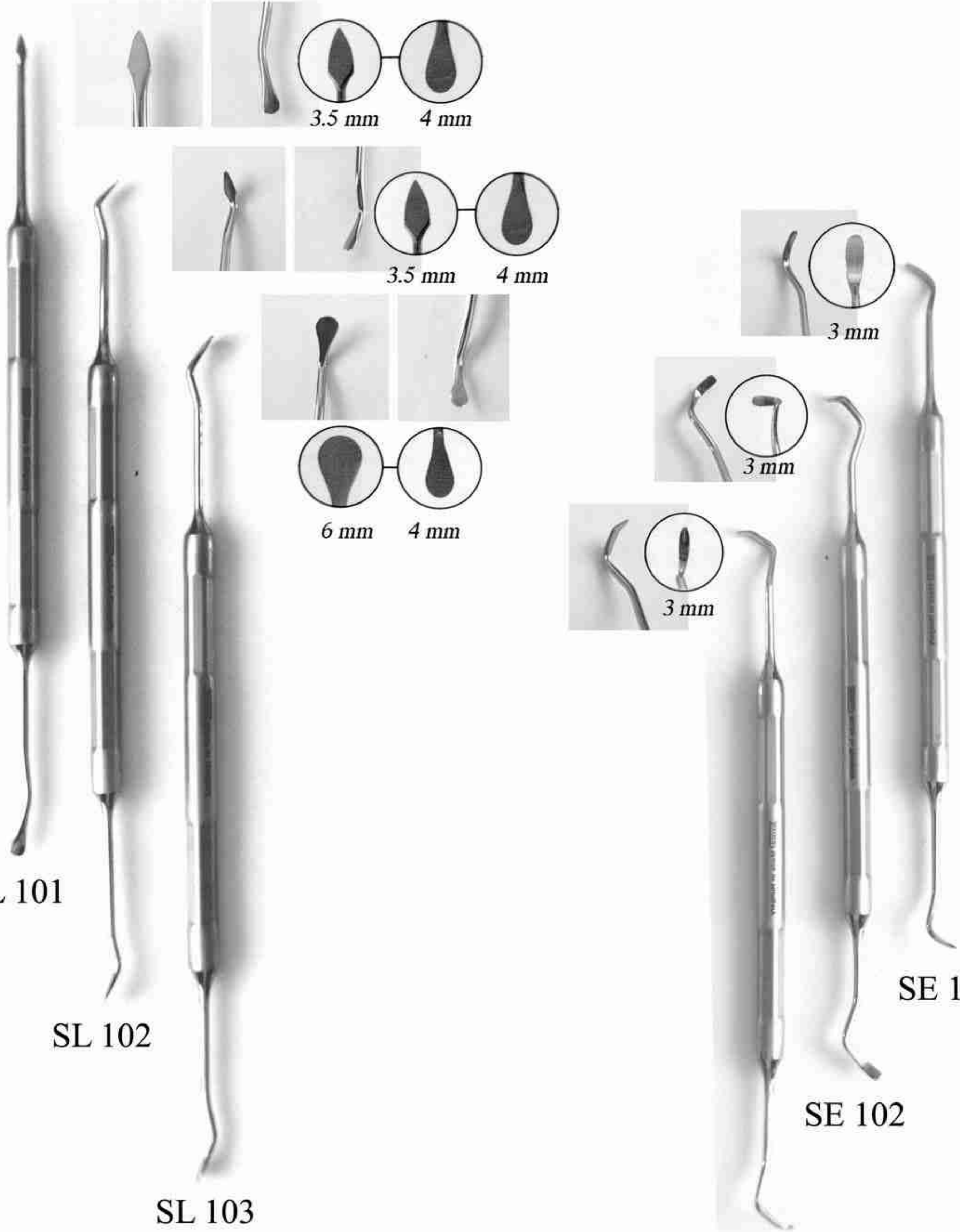

SL 101

SL 102

SL 103

SE 101

SE 102

SE 103

SINUS LIFT
SINUS LIFT INSTRUMENTE
SINUS LIFT INSTRUMENTS

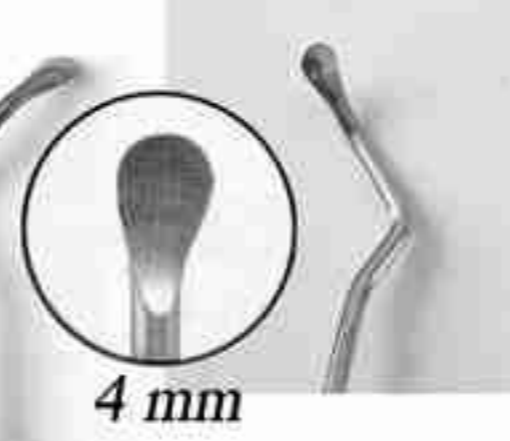
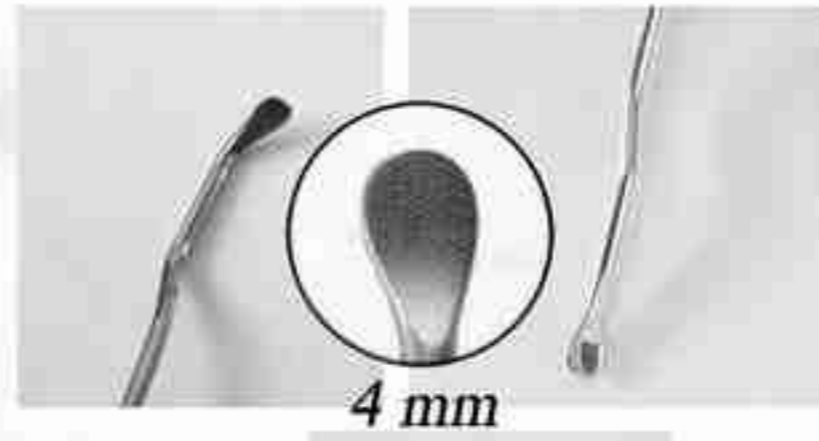
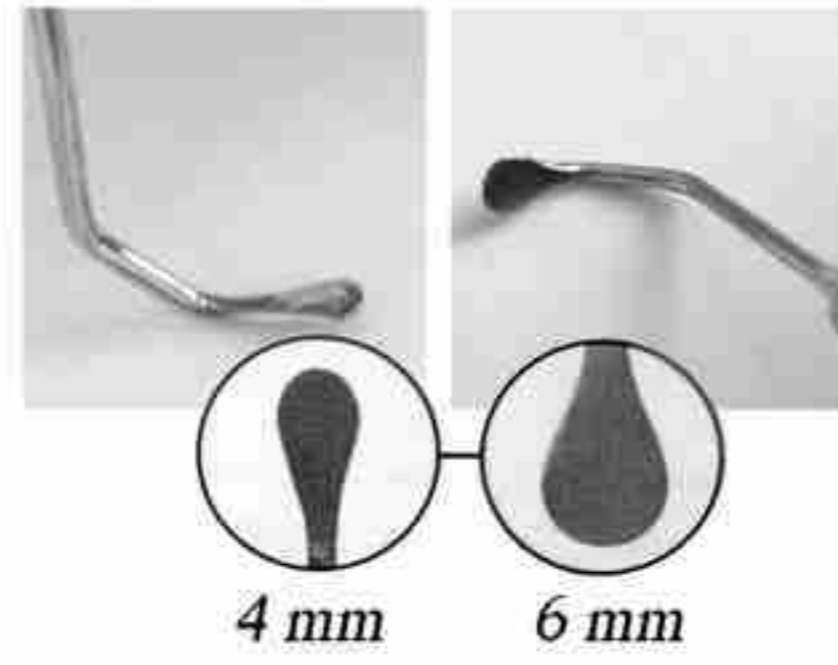
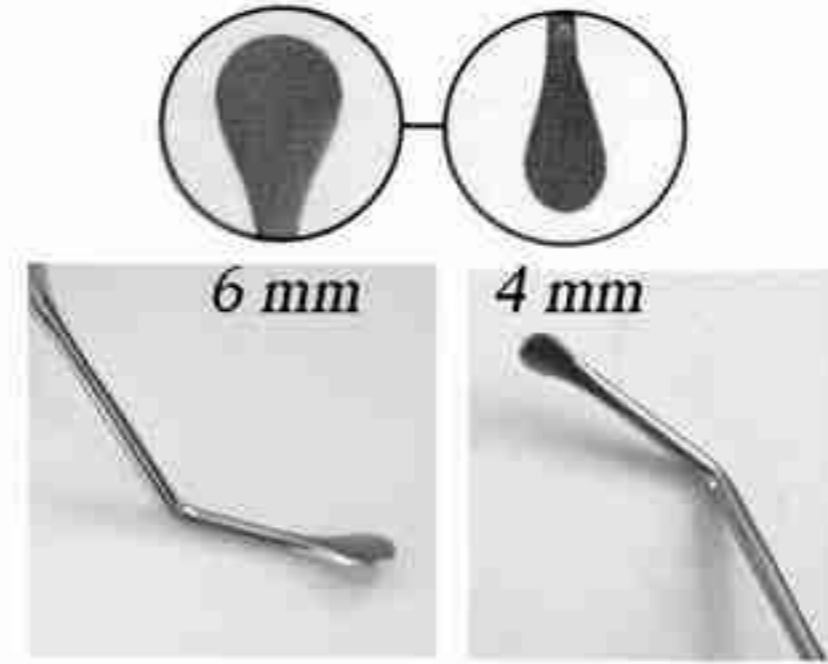
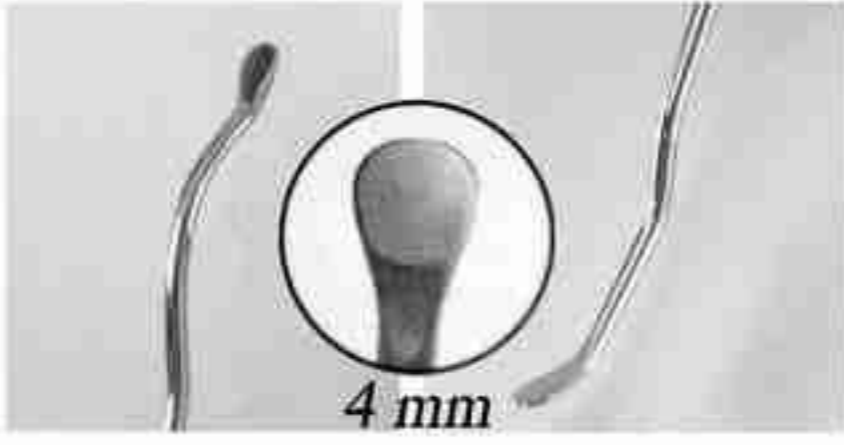
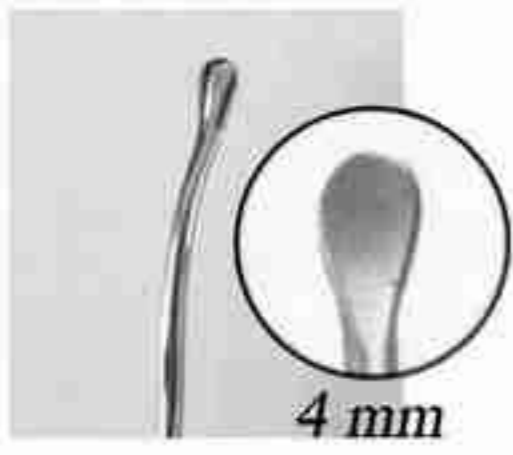

SL 104

SL 105

SL 106

SL 107

SL 108

SL 109

SINUS LIFT
SINUS LIFT INSTRUMENTE
SINUS LIFT INSTRUMENTS

CSONTCSÍPŐK - 14 cm

HOHLMEISSELZANGE -

BONE RONGUER FORCEPS



FO 1409



FO 1415



FO 1412



FO 1416

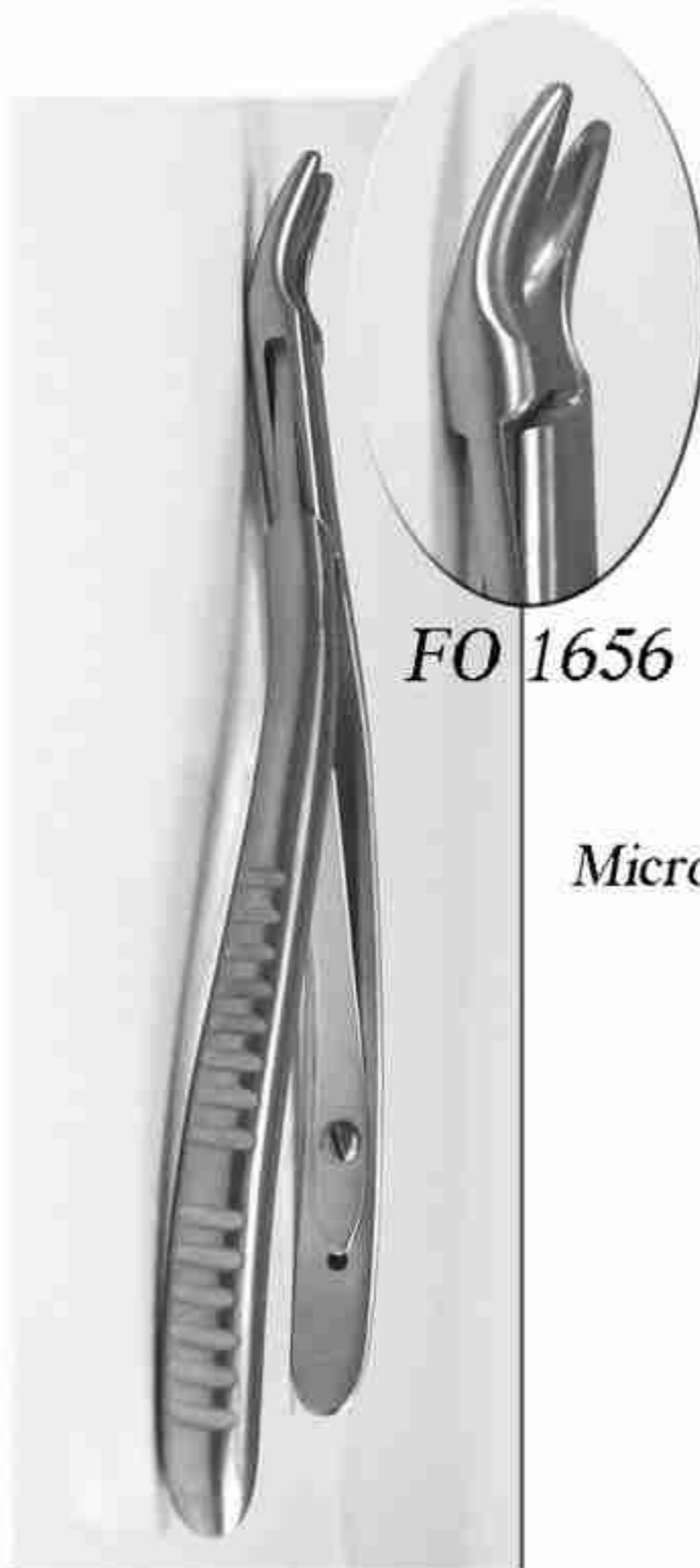

FO 1656

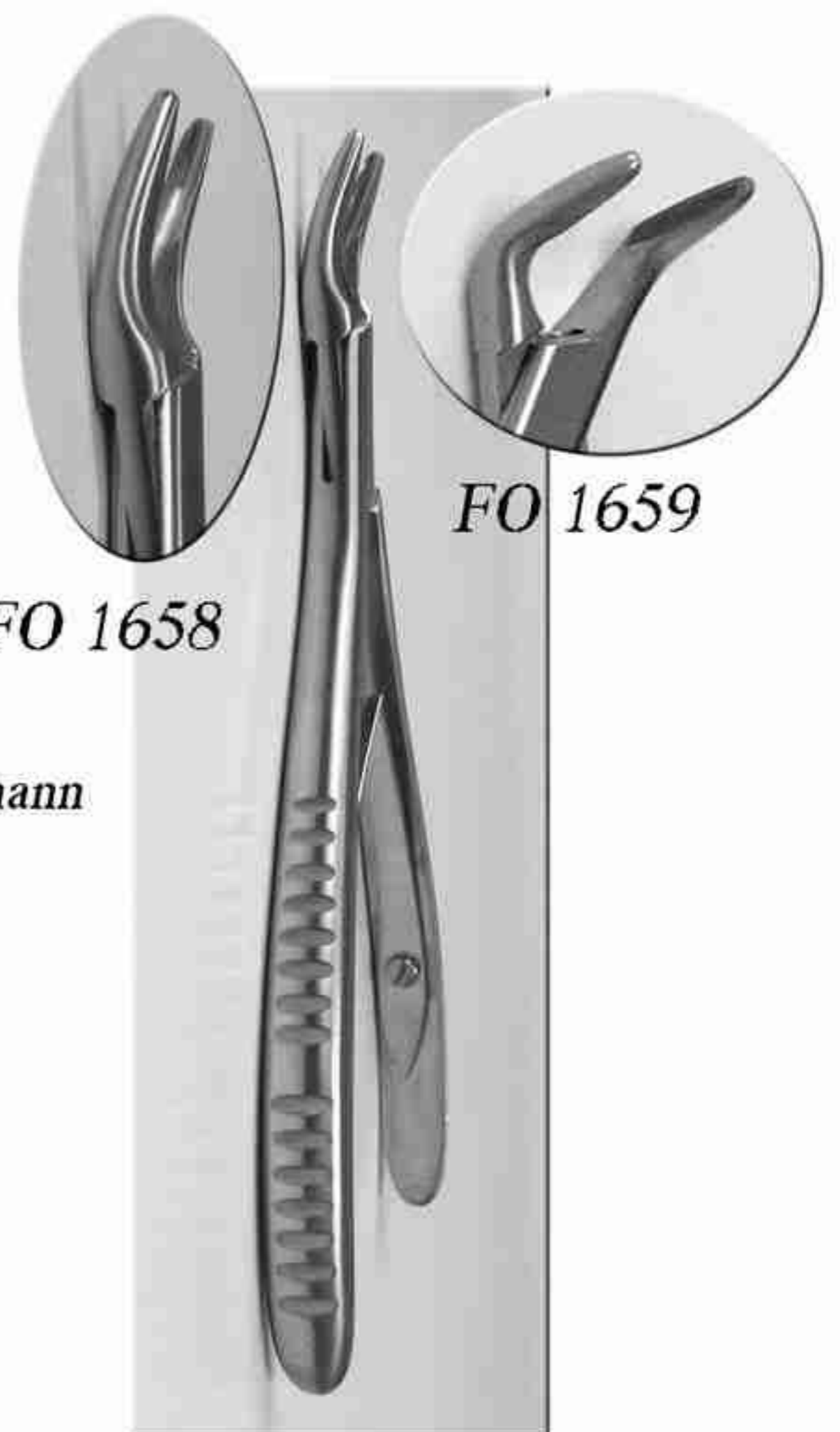

FO 1658

FO 1659

Micro Friedmann



DP 2000
KOFFERDAMM FOGÓ
KOFFERDAMM ZANGE
CLAMP FORCEPS

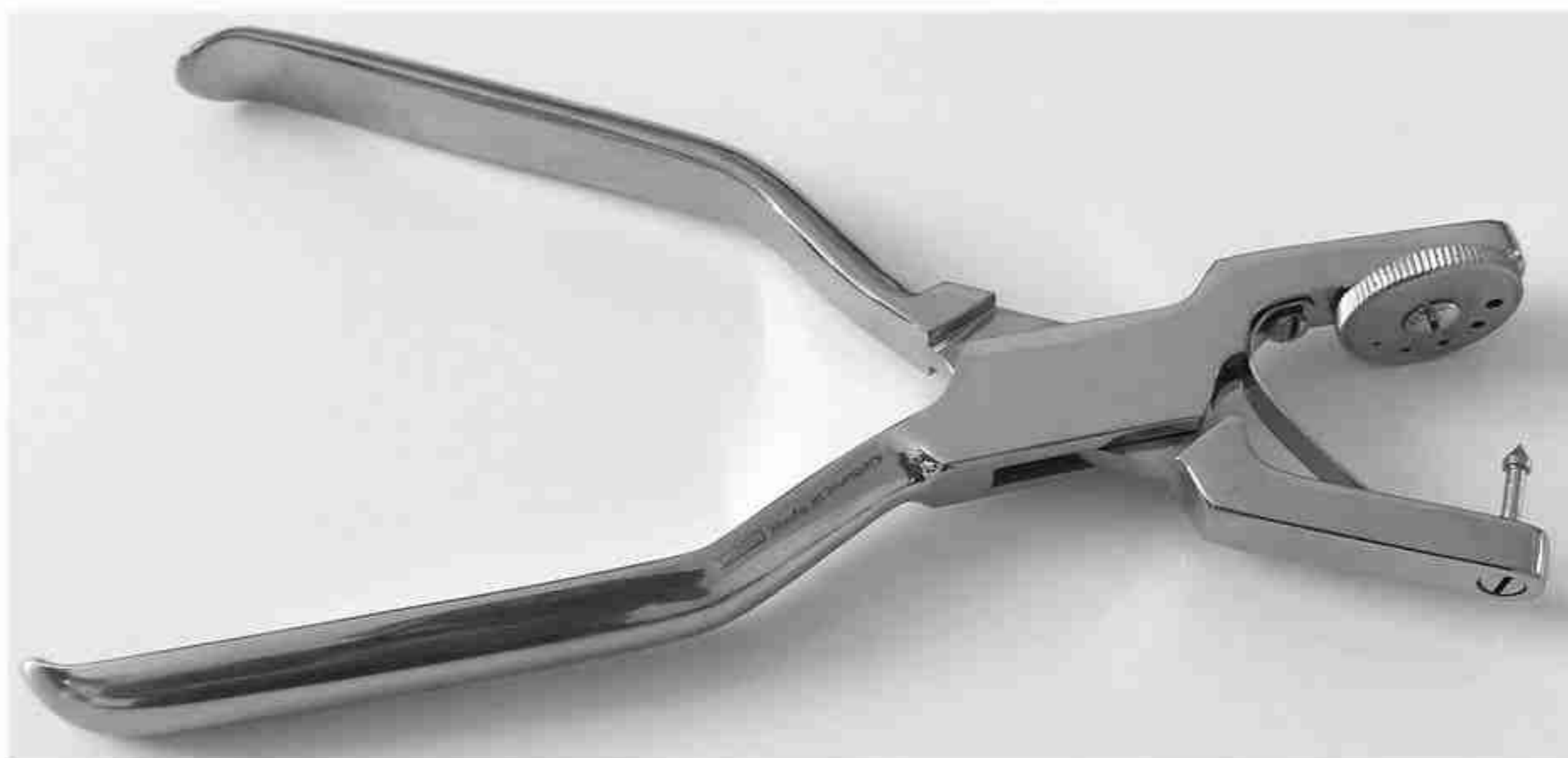

DP 2100
KOFFERDAMM LYUKASZTÓ
KOFFERDAMM LOCHZANGE
RUBBER DAM PUNCH

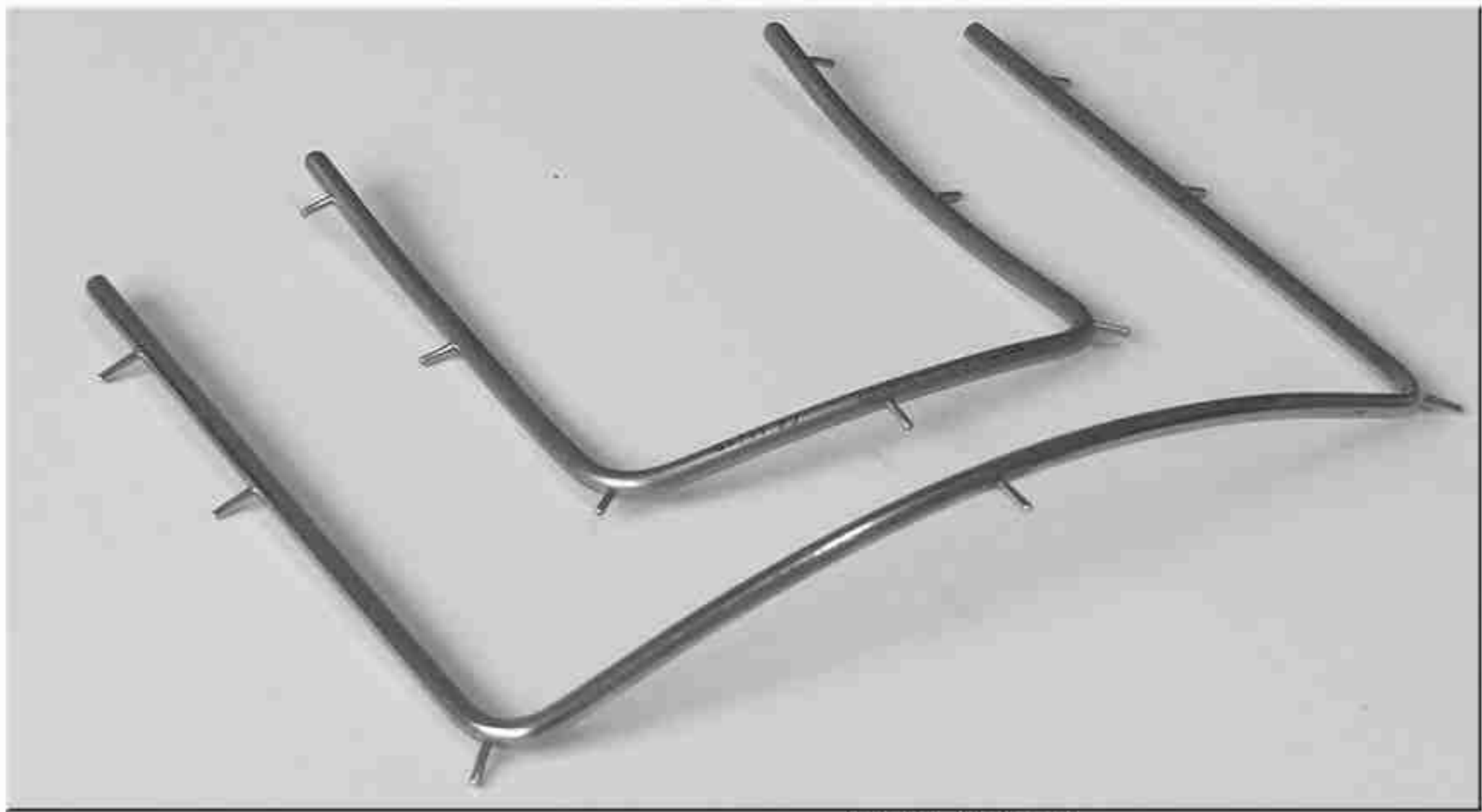

DR 2100
 KOFFERDAMM KERET
 KOFFERDAMM RAHMEN
 RUBBERDAM FRAME

DK 2100
 KOFFERDAMM KAPOCS
 KOFFERDAMM KLAMMERN
 RUBBERDAM CLAMP

212



FRONT-ANTERIOR

PREMOLÁRIS-PRAMOLAR-PREMOLAR

0



VÉKONY FOGHOZ
 MIT DÜNNEM ZAHNHALS
 FOR THIN THEETH

1



FELSŐ
 STANDARKLAMMER
 FÜR OBERE PRAMOLAREN
 STANDARDCLAMP FOR
 UPPER PREMOLARS

2



ALSÓ
 STANDARKLAMMER
 FÜR UNTERE PRAMOLAREN
 STANDARDCLAMP FOR
 LOWER PREMOLARS

27



ALSÓ-FELSŐ
 FÜR OBERE UND UNTERE
 PRAMOLAREN
 FOR UPPER AND LOWER
 PREMOLARS

MOLÁRIS-MOLAR-MOLARE

7



ALSÓ
 STANDARKLAMMER
 FÜR UNTERE MOLAREN
 STANDARDCLAMP
 FOR LOWER MOLARS

8



FELSŐ
 STANDARKLAMMER
 FÜR OBERE MOLAREN
 STANDARDCLAMP
 FOR UPPER MOLARS

8A



GYÖKÉR ALSÓ-FELSŐ
 WURZELKLAMMER FÜR OBERE
 UND UNTERE MOLAREN
 ROOTCLAMP FOR UPPER
 AND LOWER MOLARS

14A



FERDE FOGAKHOZ
 FÜR SCHRAGSTEHENDE
 MOLAREN
 FOR OBLIQUE THEETH

64.

TENTECH

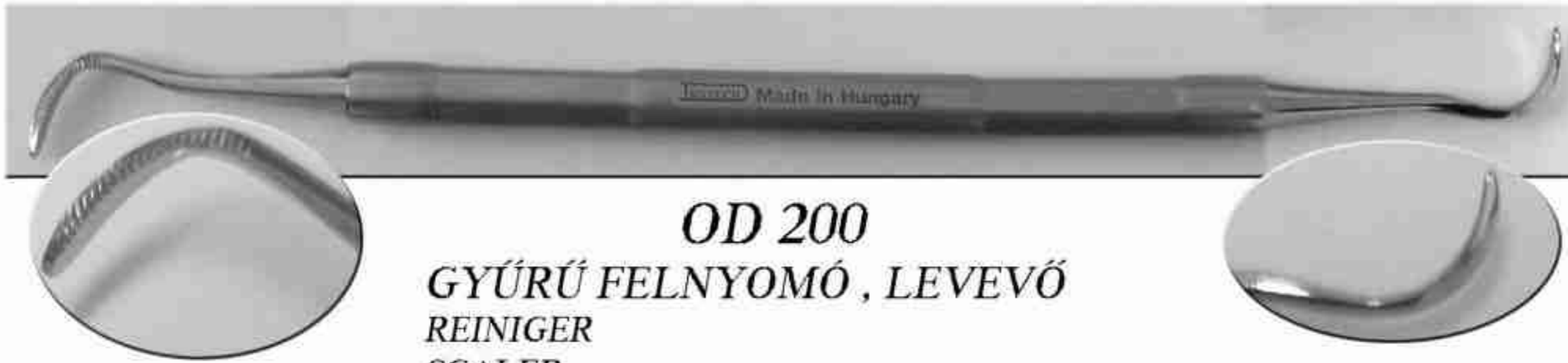

OD 200
GYŰRŰ FELNYOMÓ, LEVEVŐ
REINIGER
SCALER



OD 1756
GYŰRŰFELNYOMÓ
BANDAUFSETZER
BAND PUSHER



OD 202 17 cm
STOKE
SZEPARÁLÓ GUMIGYŰRŰ FELRAKÓ FOGÓ
SEPARIERZANGE ZUM SPREIZEN DER
DENTALASTIC-SEPARIERRINGE VOR DEM POSITIONIEREN
SEPARATING PLIERS FOR EXPANDING DENTALASTICS
BEFORE POSITIONING

TÚFOGÓK - NADELHALTER - NEEDLE HOLDERS
 KEMÉNYFÉM BETÉTES

TC

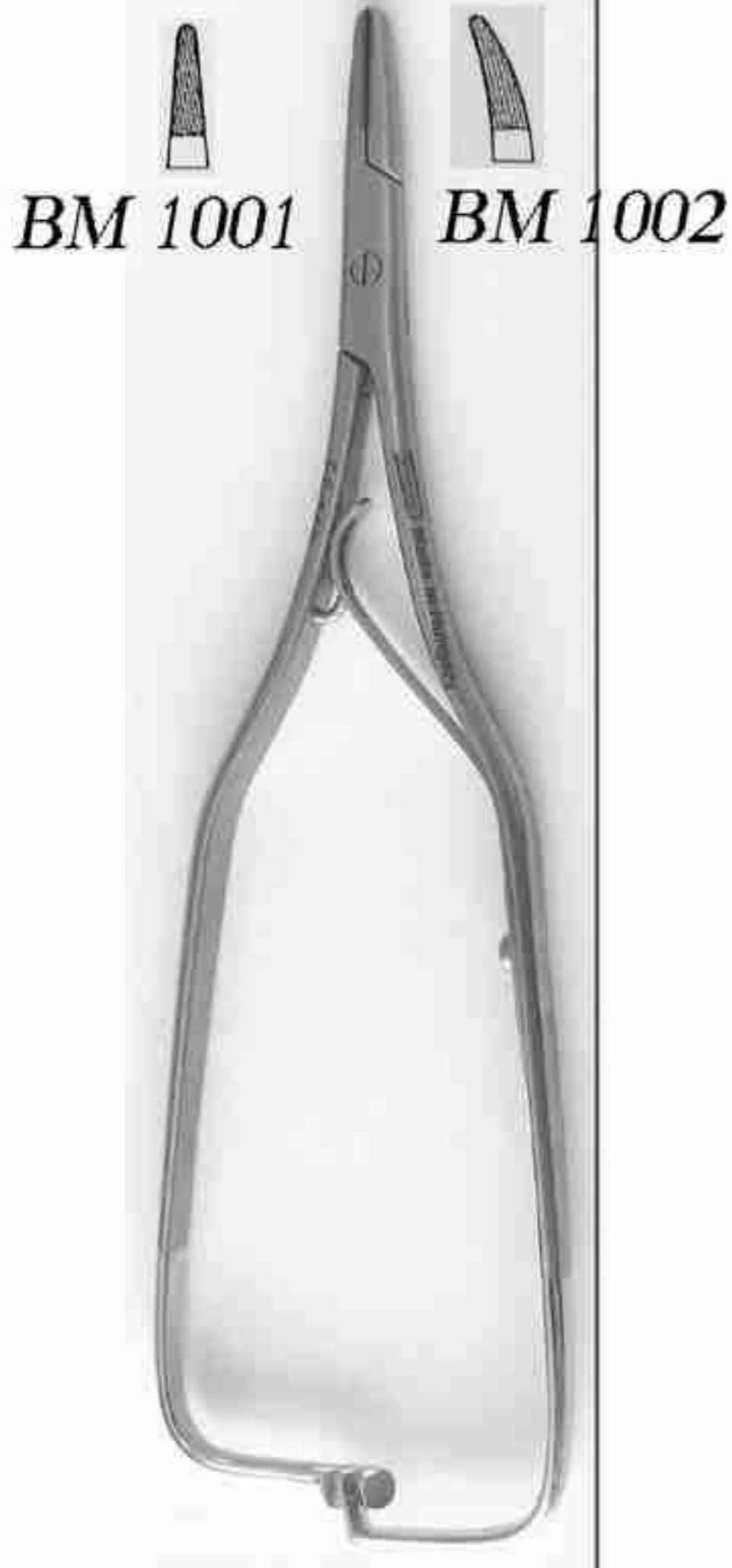

BM 1001

BM 1002

ARRUGA
 16 cm

KEMÉNYFÉM BETÉTES

TC

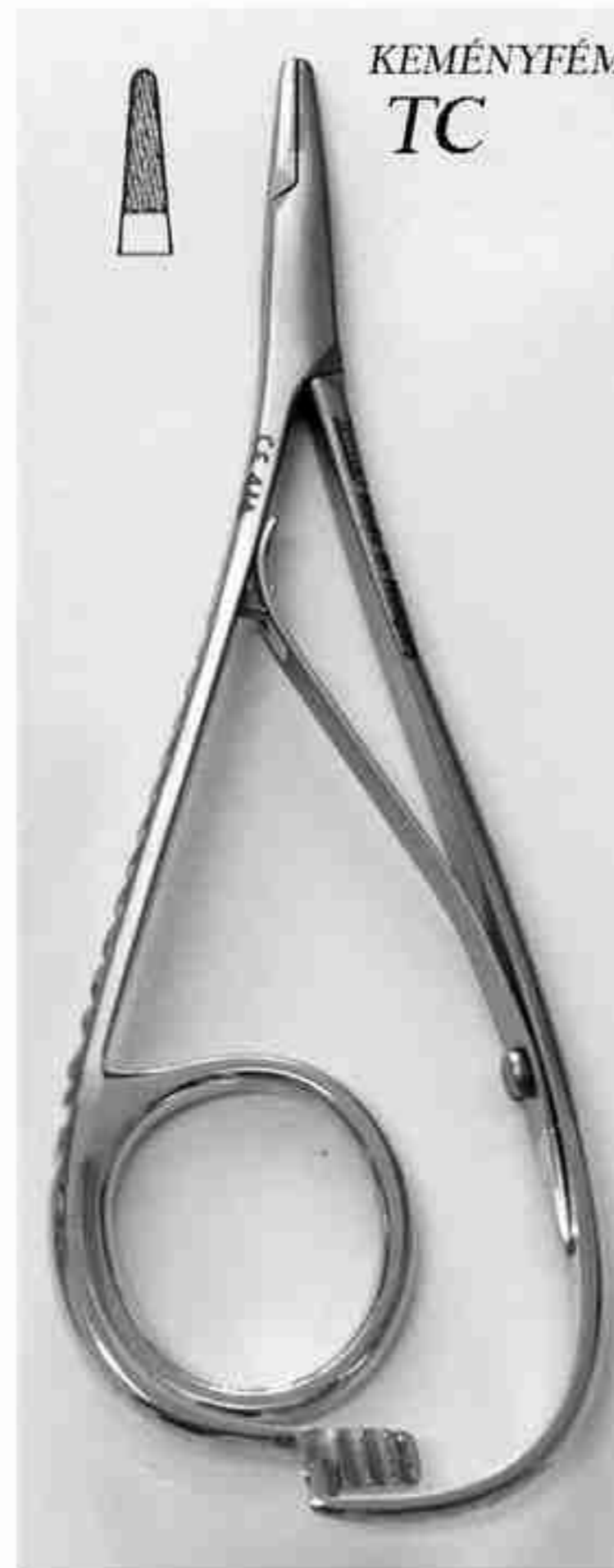

BM 1000
 BACHMANN
 14 CM



14 cm



OD 1000
 BRACKET CSIPESZ
 BRACKET-PINZETTE
 BRACKET PLACING TWEEZERS



OD 1307
 BRACKET LEVEVŐ FOGÓ
 BRACKET-ABNEHME ZANGE
 BRACKET REMOVING PLIERS

KEMÉNYFÉM BETÉTES

TC



OD 100
DISZTÁLVÁGÓ KFB.
DISTAL-SCHNEIDER TC.
DISTAL CUTTER TC.

14 cm

MAX 0,18 X 0,22 mm

KEMÉNYFÉM BETÉTES

TC



OD 101
LIGATÚRVÁGÓ KFB.
LIGATURENSCHNEIDER TC.
LIGATURE CUTTING PLIERS TC.

13 cm

MAX 0,7 mm



DP 1500

DRÓTVÁGÓ
DRAHTSCHNEIDEZANGEN
WIRE CUTTERS

14 cm

MAX 1,2 mm

MAX 0,9 mm

LIGATURA FOGÓK
LIGATUREN ZANGE
LIGATURE FORCEPS



OD 201

LIGATURA ADAPTER
LIGATURENADAPTER
LIGATURE TUCKER

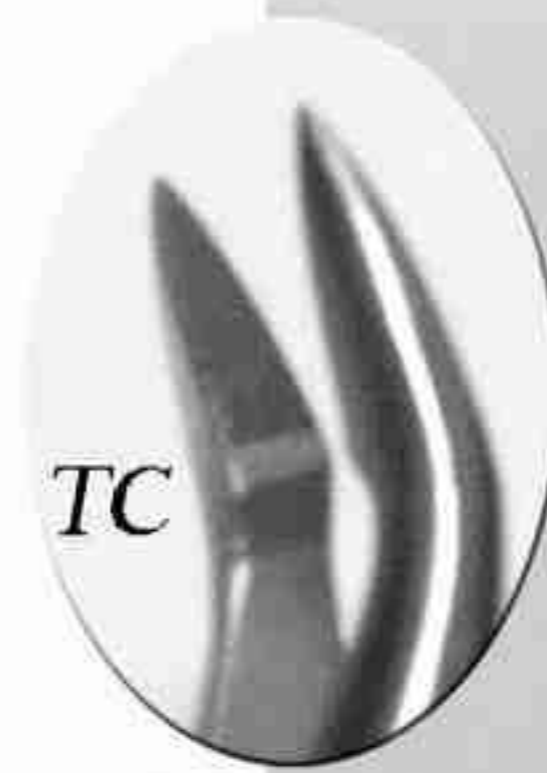

TC

OD 102

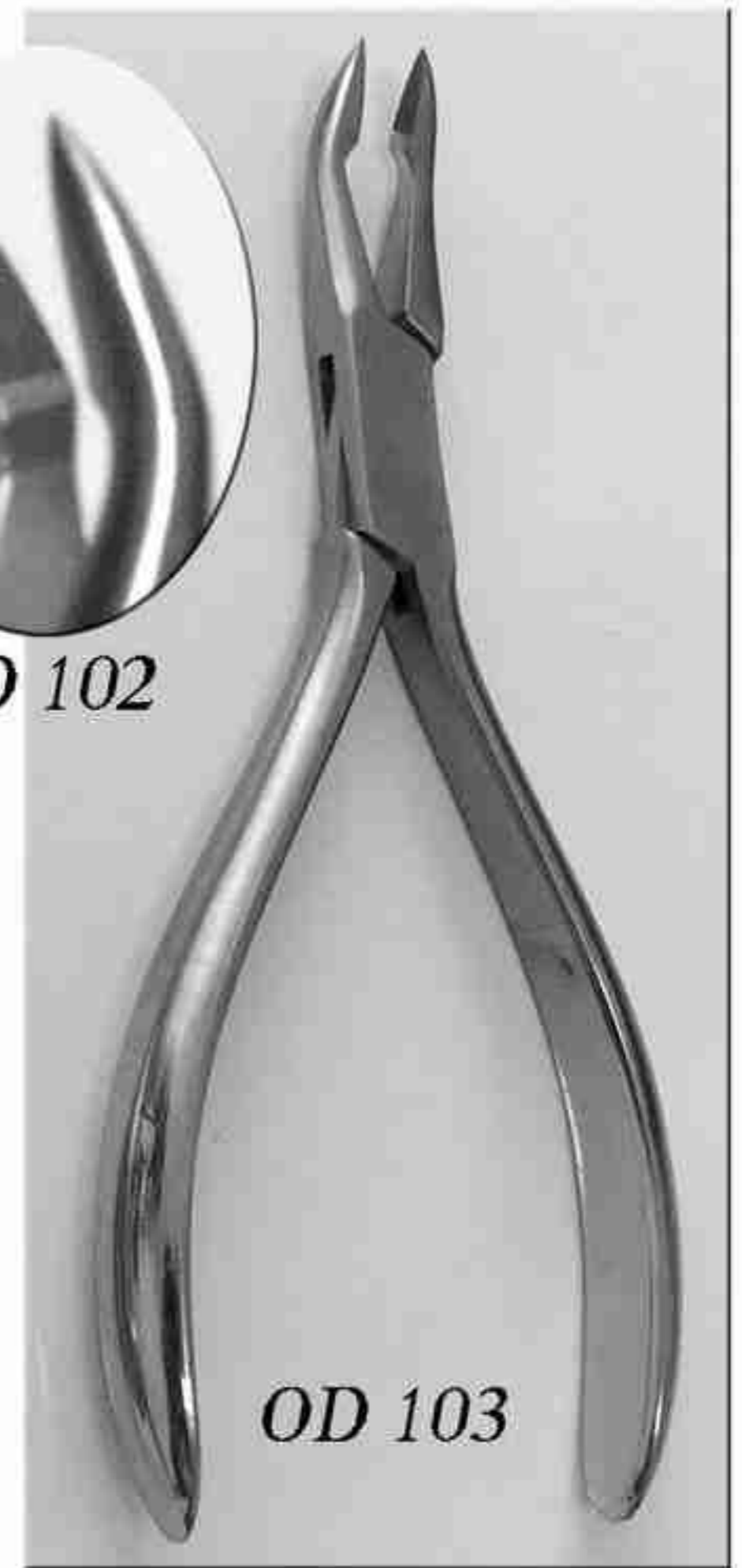

OD 103

WEINGART 14 cm



DP 1390

HOW 14 cm



DP 1393

HOW 14 cm

TELESZKÓP KORONAFOGÓ -
TELESKOP KRONEN ZANGE -
TELESCOPE CROW PLIERS

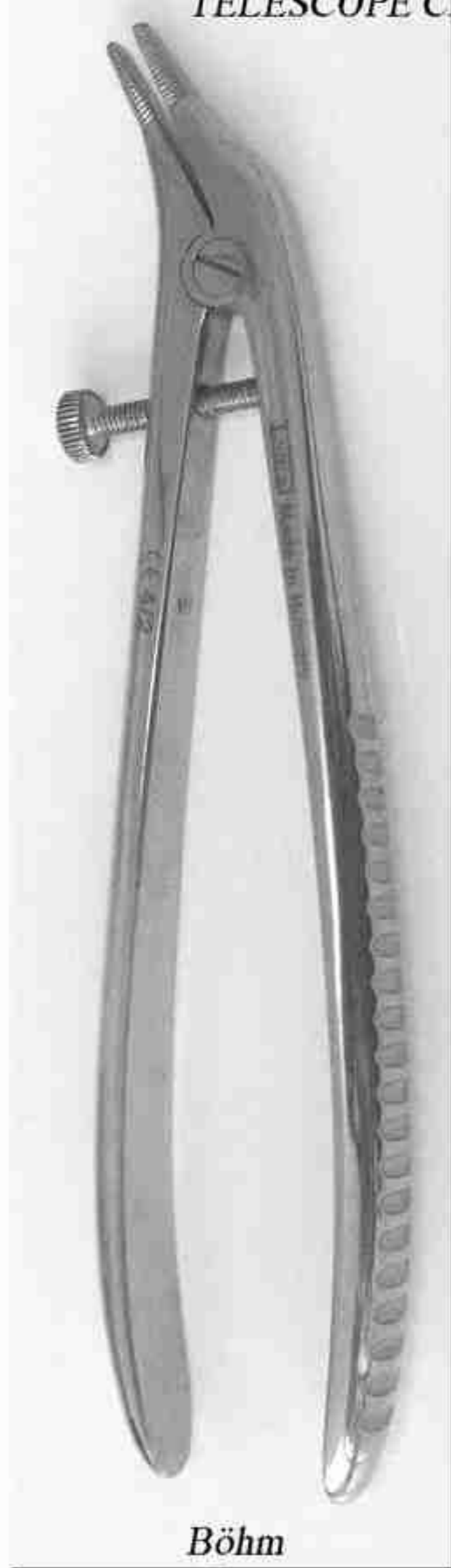

Böhm
15 cm

FOGTECHNIKAI FOGÓK
TECHNIK ZANGE
TECHNICAL PLIERS

MAX 0,9 mm



DP 1505 15 cm
UNIVERZÁLIS
KRAMPONFOGÓ
UNIVERSAL-KRAMPONZANGE
UNIVERSAL TECHNICAL PLIERS

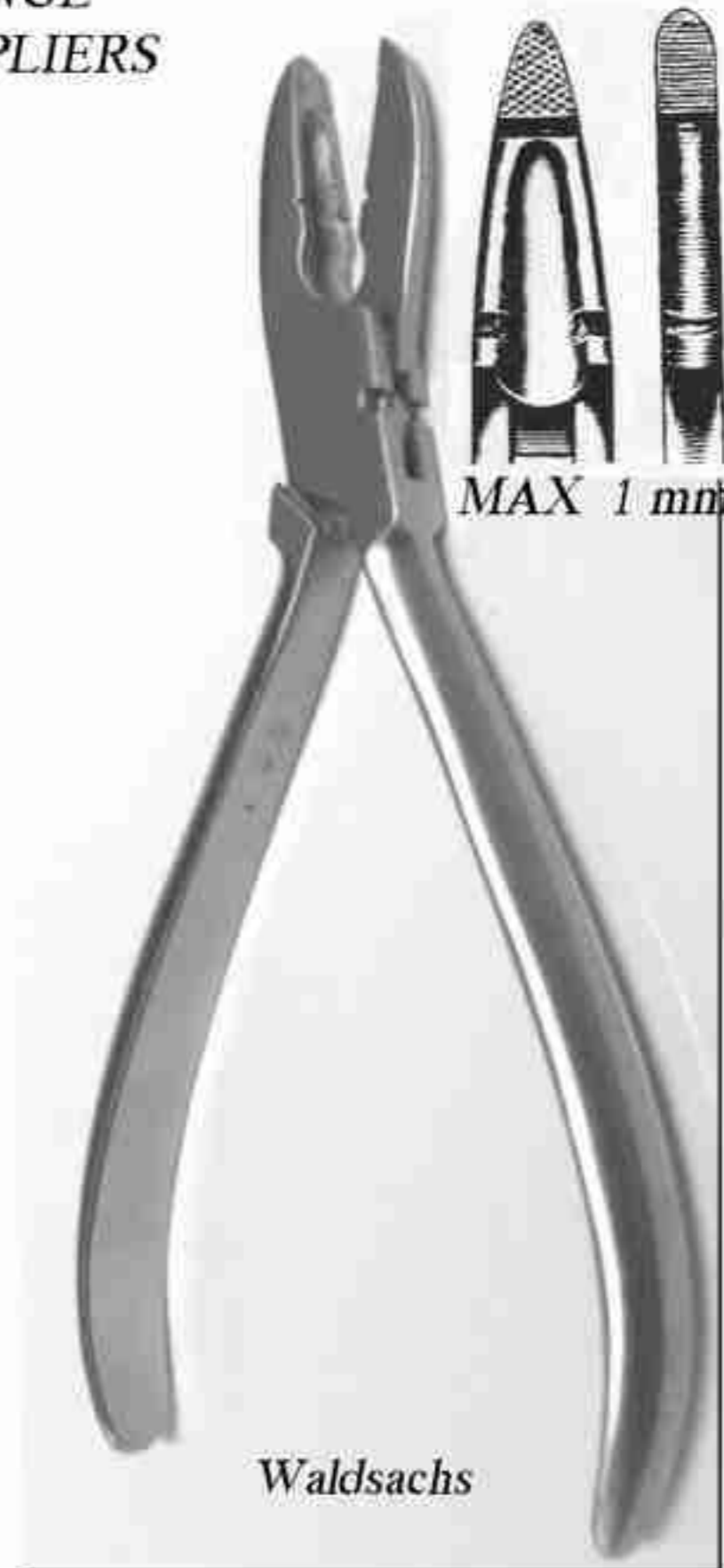

Waldsachs

DP 1360 15 cm

MAX 0,9 mm



KRAMPONFOGÓ
KARAMPON ZANGE
UNIVERSAL
TECHNICAL PLIERS

DP 1501 15 cm

BÖHM	a	b	c	d
DP 1739	3,3	4,0	2,3	3,0 mm
DP 1740	4,4	5,0	3,4	3,8 mm

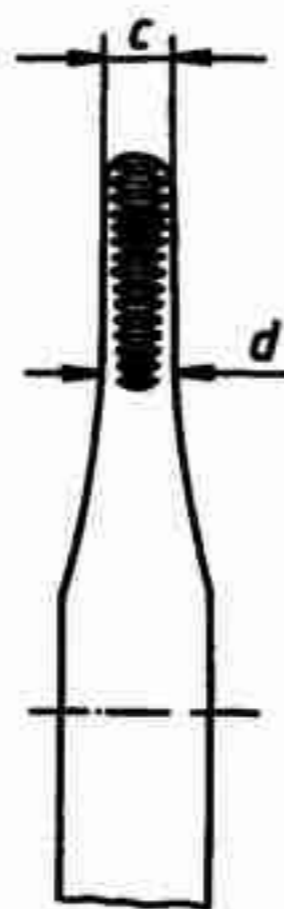
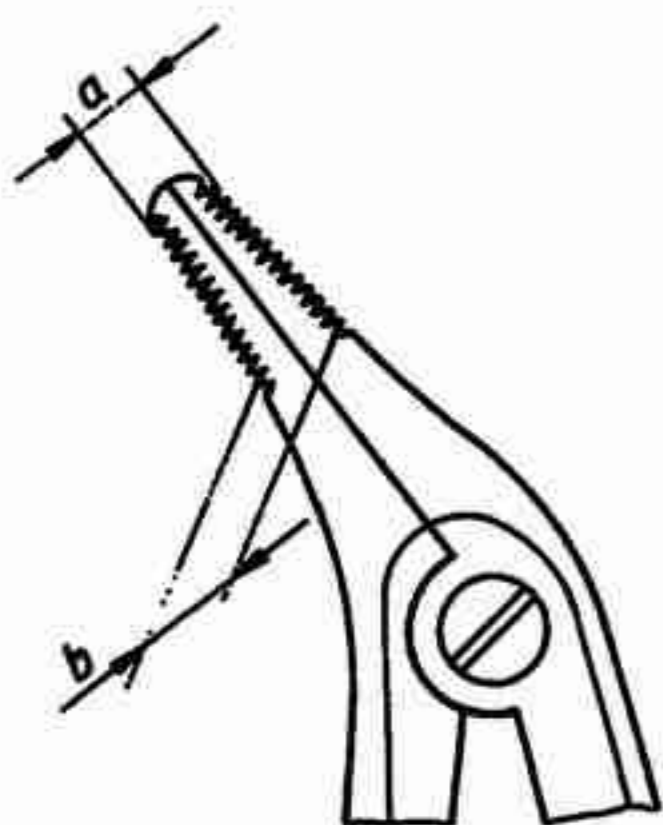

DRÓTHAJLÍTÓ FOGÓK MAX 0.7 mm
DRAHTBIEGEZANGEN
WIRE BENDING PLIERS



DP 1122 14 cm
LANGENBECK



DP 1315 13 cm
ADERER



DP 1316 13 cm
ADERER

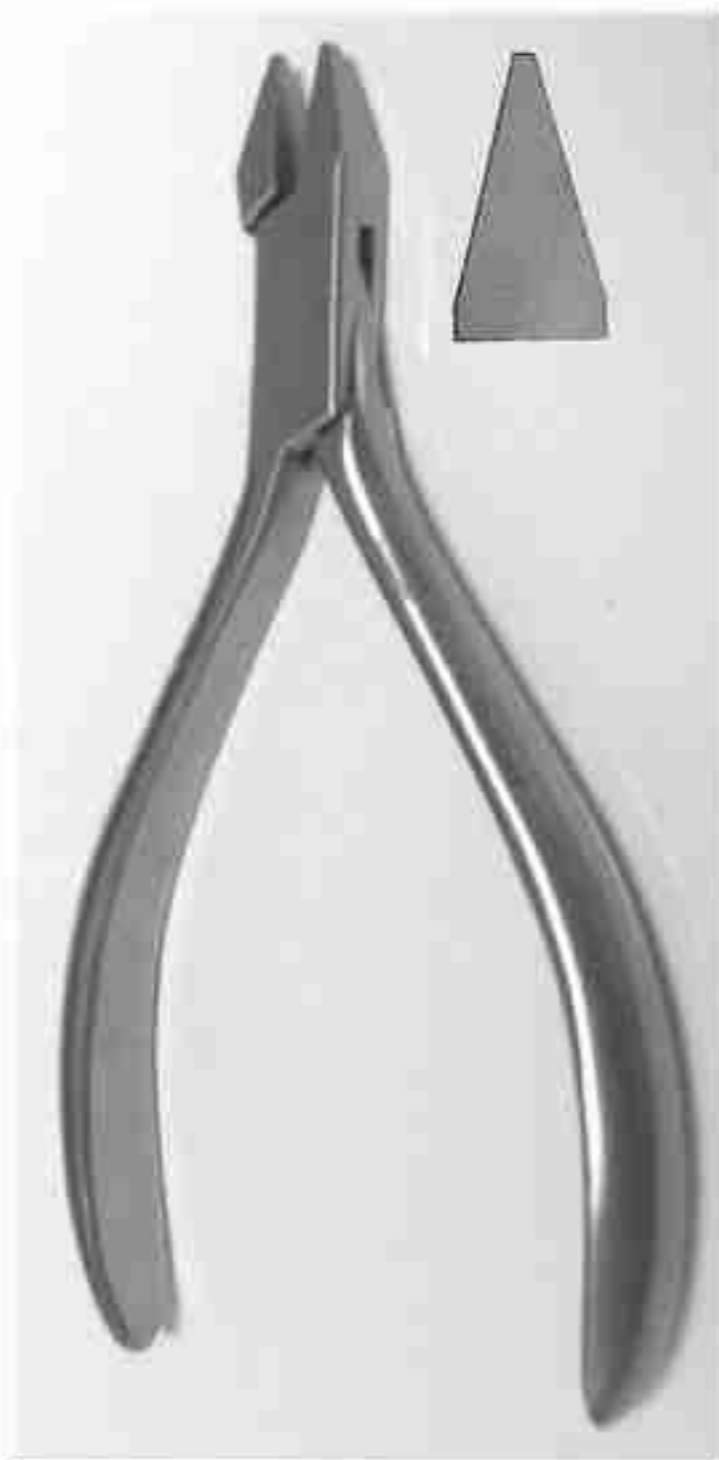

DP 1312 13 cm
ADAMS

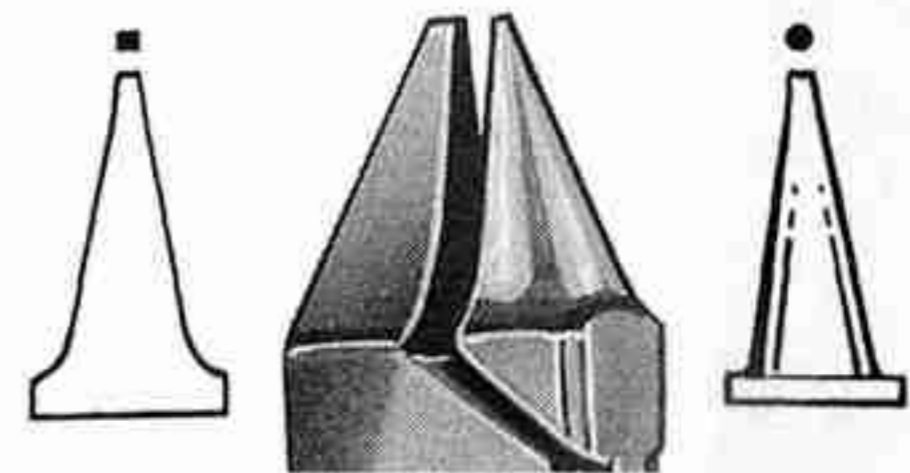

DP 1310 13 cm
ANGLE

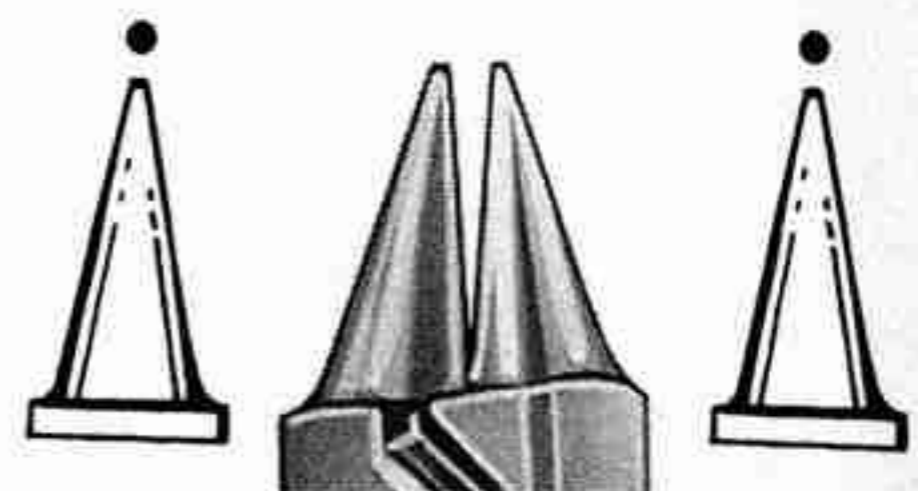

DP 1311 13 cm
ANGLE

LAPOS FOGÓK - FLACHZANGEN - FLAT NOSE PLIERS



14 cm



DP 11



DP 12



DP 111



DP 122

1/1



DP 135



DP 132

ÍVHAJLÍTÓ FOGÓK - DRAHTBIEGEZANGEN - WIRE BENDING PLIERS



DP 1141 16 cm

Mc KELLOPS



14 cm

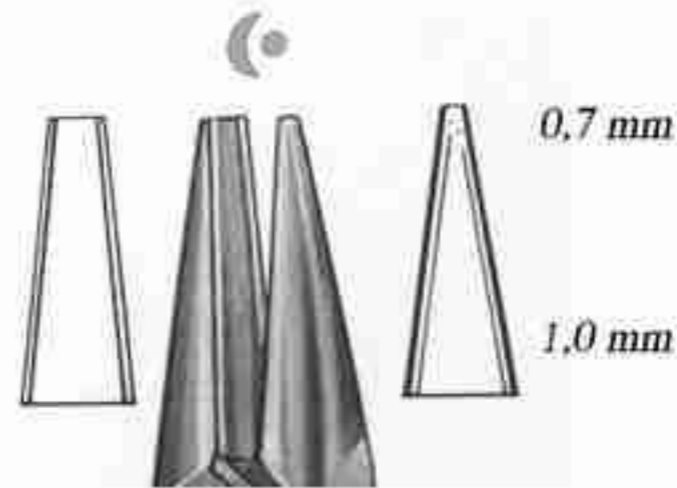

DP 1133

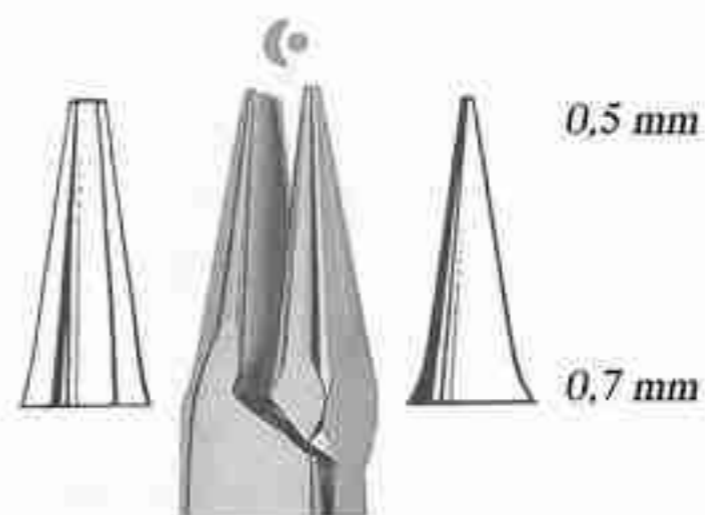

DP 1134
SCHWARTZ

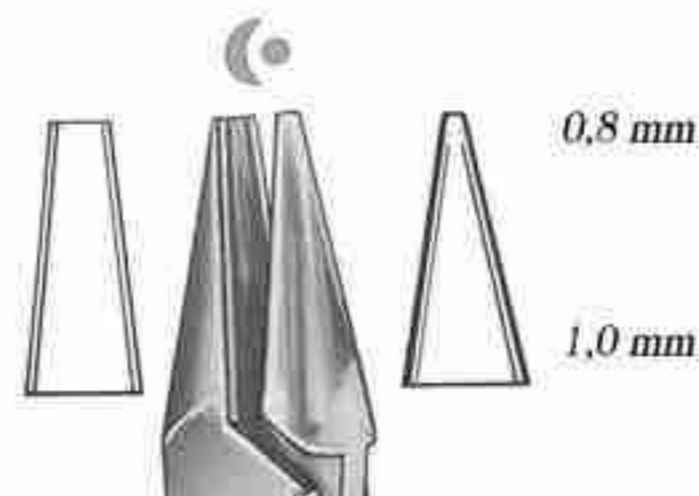

DP 1135
FISCHER

DRÓTHAJLÍTÓ FOGÓK - DRAHTBIEGEZANGEN - WIRE BENDING PLIERS



DP 1301 14 cm
TWEED

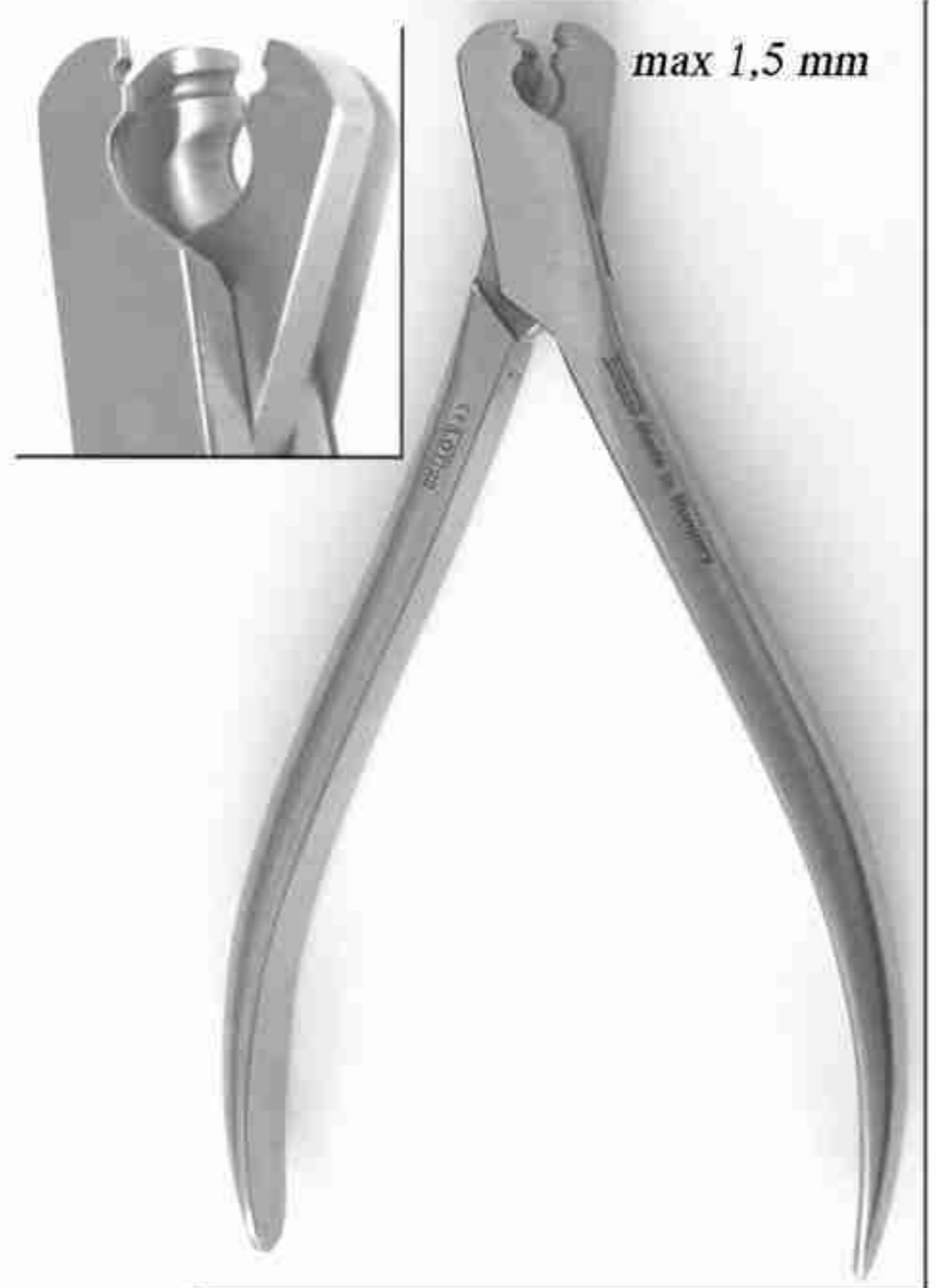

DP 1355 14 cm
ADERER



DP 1324 14 cm
De Larosa

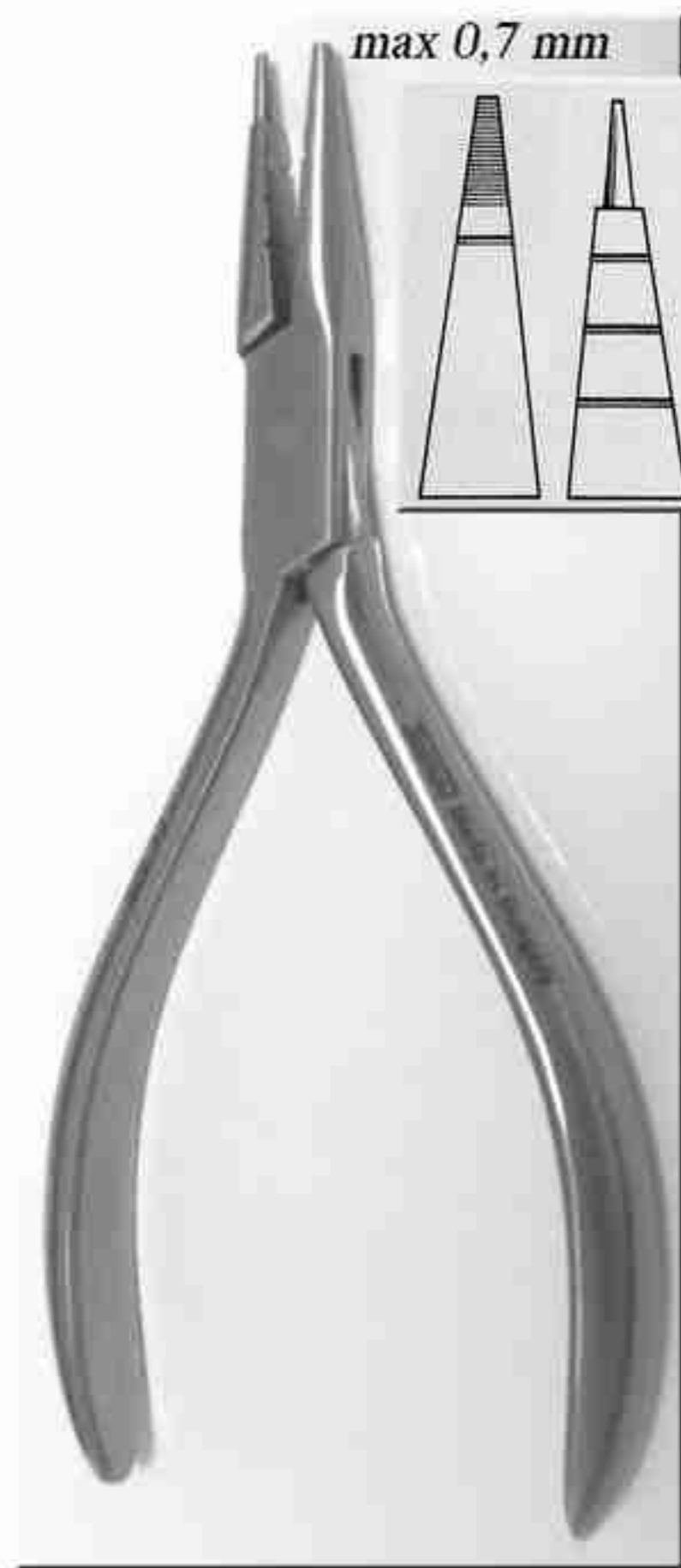

DP 1308 14 cm
JARABAK



DP 1323 14 cm
YOUNG



OD 1327 14 cm

NANCE

LÉPCSŐS HAJLÍTÓ FOGÓ

SCHLAUFENBIEGEZANGE

LOOP FORMING PLIERS



OD 1317 13 cm

TWEED

ÍVFORMÁZÓ FOGÓ

BOGENFORMZANGEN

ARCH FORMING PLIERS

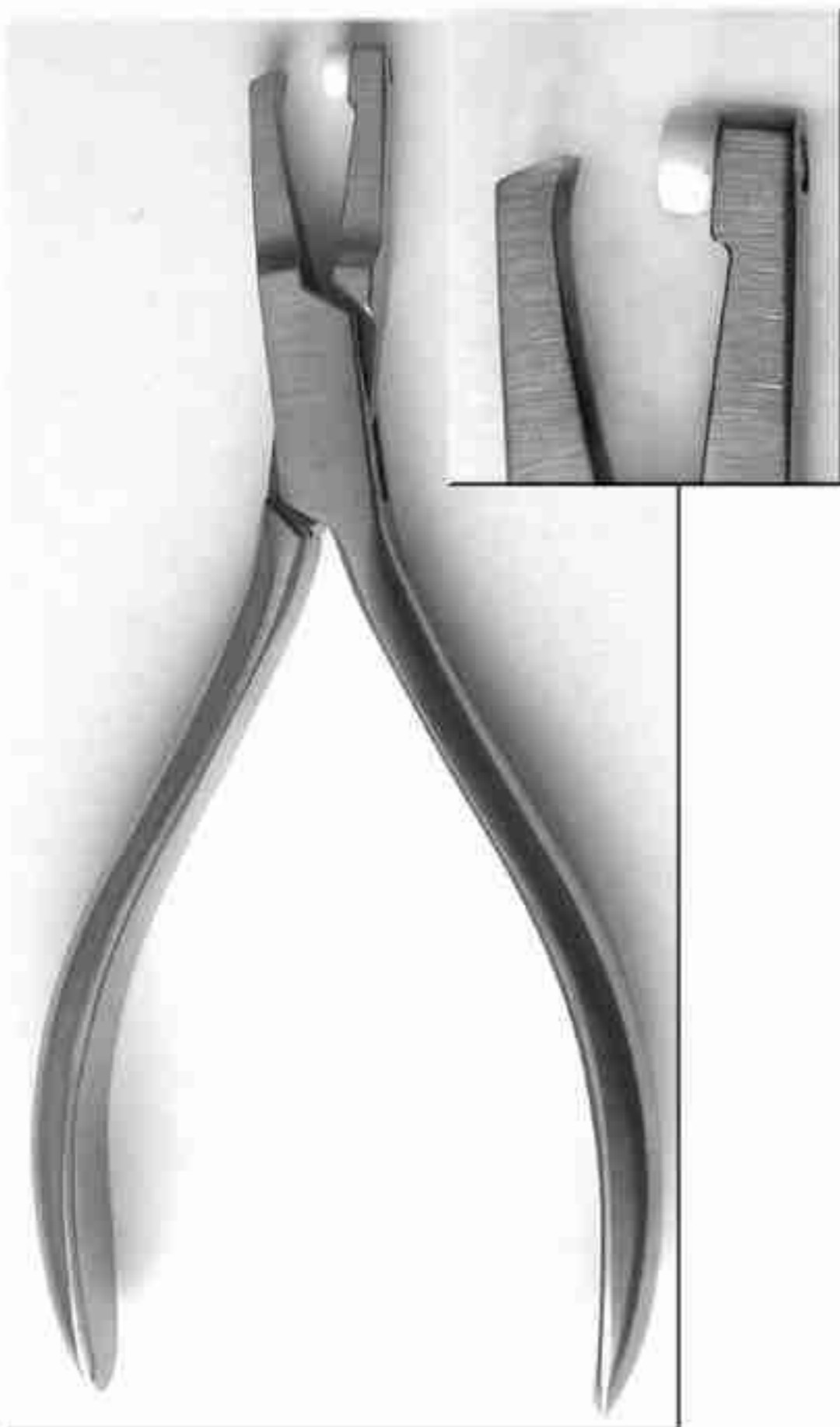

OD 1306 14 cm

GYÚRÚ LEVEVŐ FOGÓ TEFLON BETÉTTTEL

BAND-ABNEHME ZANGE MIT TEFLON EINZATZ

BAND REMOVING PLIERS WITH TEFLON INSERT

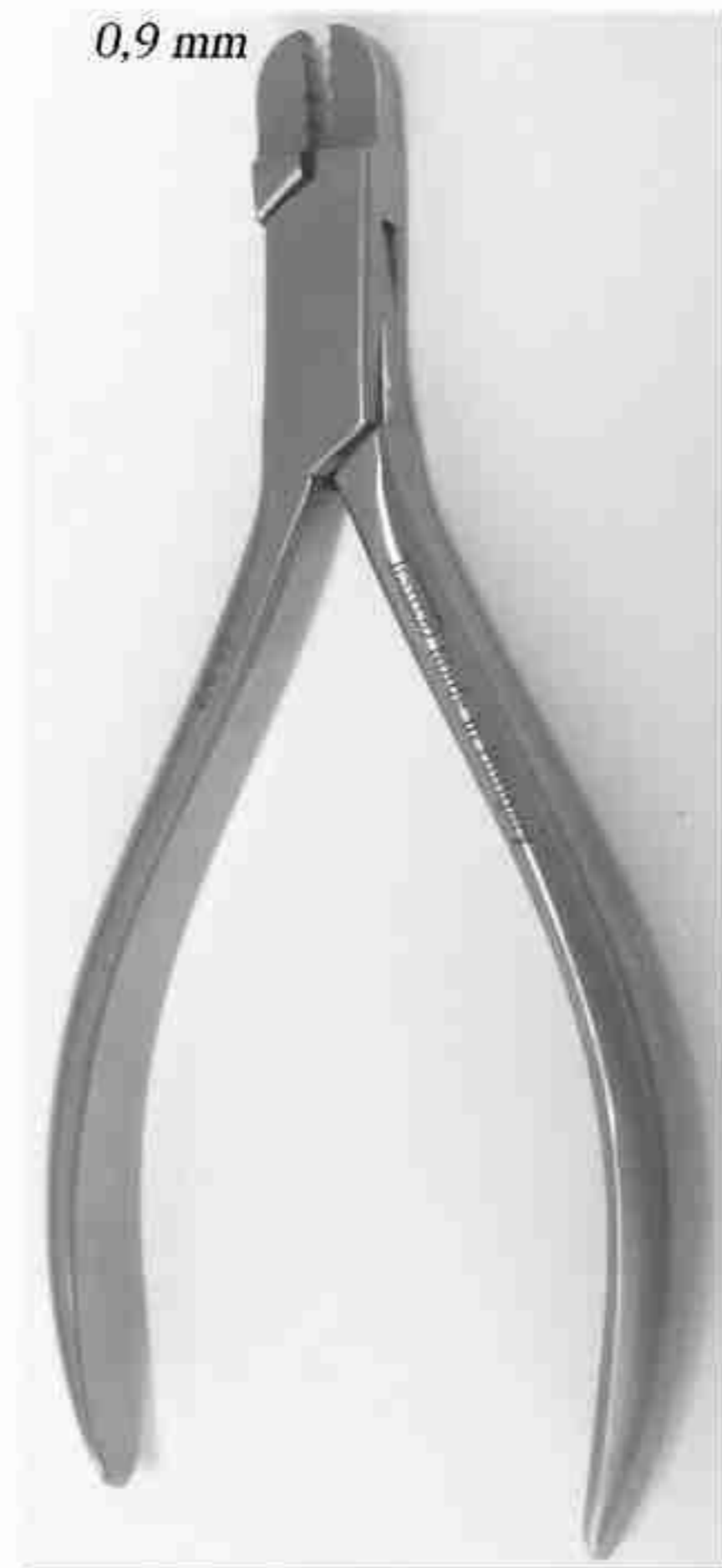

OD 1337 14 cm

KENGYELHAJLÍTÓ FOGÓ

BÜGELBIEGEZANGE

LINGUAL ARCH BENDING PLIERS

FOGTECHNIKAI MINTÁZÓ -

MODELLIER INSTRUMENTE

MODELLING INSTRUMENTS

DS 1301



DS 1302



DS 1303



DS1304



DS 1305



DS 1306



DS 1307



74.

FOGTECHNIKAI MINTÁZÓ -

MODELLIER INSTRUMENTE

MODELLING INSTRUMENTS

DS 1308



DS 1309



DS 1310



DS 1311



DS 1312



DS 1313



DS 1314



AKRILÁT FELRAKÓ - AKRYLATE INSTRUMENTE - ACRYLATE MODELLING INSTRUMENTS**DS 1401****DS 1402****DS 1403**

P. K. THOMAS FELRAKÓK
MODELLIERINSTRUMENTE
P. K. THOMAS INSTRUMENTS

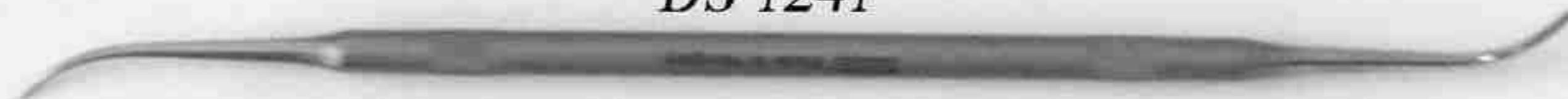
DS 1241**DS 1242****DS 1243****DS 1244****DS 1245**

GRAVÍROZÓ - GRAVIERER - ENGRAVER

DS 1405**DS 1404**

KERÁMIASZEPARÁLÓ KÉS
SEPARIERMESSER AUS KERAMIK
SEPARATE KNIFE FOR CERAMICS

DS 100



0,1 mm

DS 101



TIPUS/TYP/TYPE FIG.11

PATRONOS BEFOGÓ
PATRONENSPANNER
CARTRIDGE CLAMP



DS 1350



DS 1353

GRAVÍROZÓ BETÉTHEGY
EINSATZSPITZ FÜR
GRAVIERINSTRUMENTE
TIP FOR CATRIDGE CLAMP



DS 103

12,5 cm



DS 102

KORONAFOGÓ KERÁMIA FELRAKÁSÁHOZ
KRONENHALTEKLEMMEN
CROWN HOLDING CLAMPS

ALGINATE ÉS GIPSZSPATULÁK
SPATELN FÜR ALGINAT UND GIPS
ALGINAT AND PLASTER SPATULAS

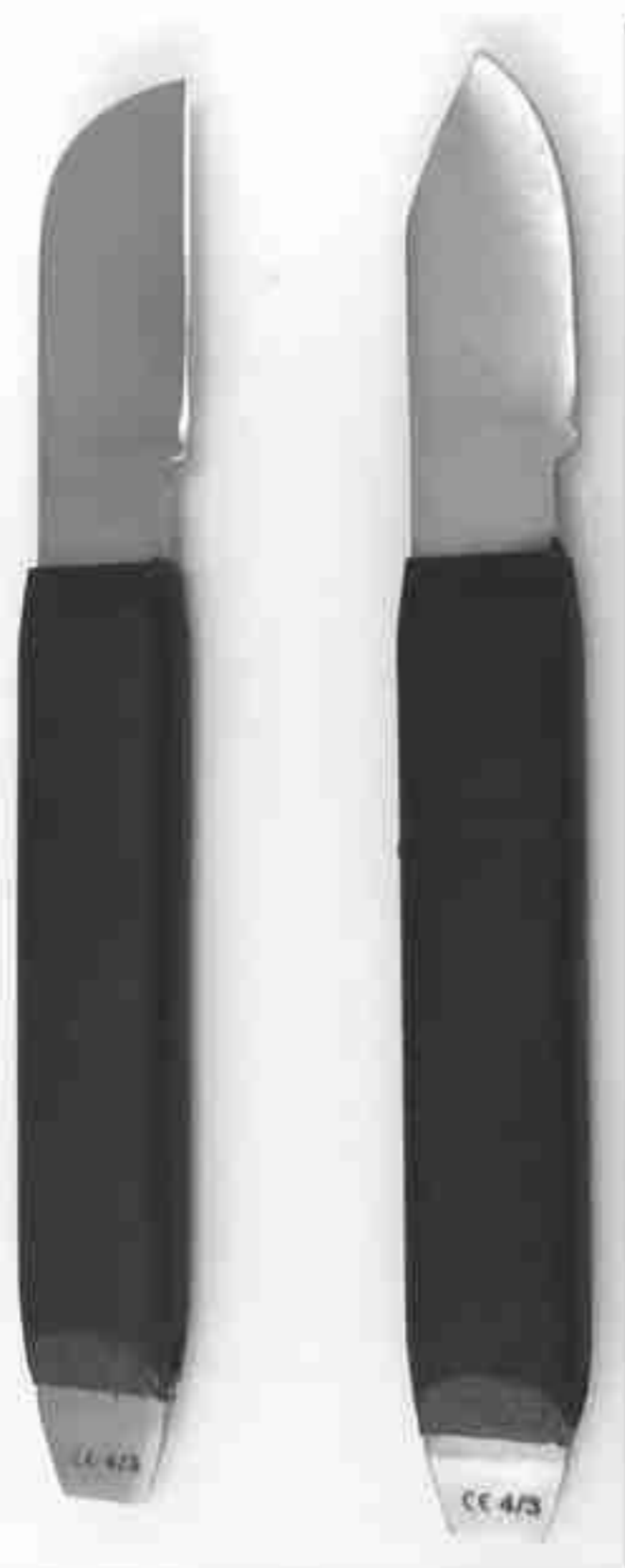

DS 160 DS 161

GIPSZKÉSEK
GIPSMESSER
PLASTER KNIFE

16 cm



DS 115 DS 118

DS 120
GIPSZLAPOC
GIPSSPATELN
PLASTER SPATULAS

Lichtenstein



VIASZKÉSEK
WACHSMESSER
WAX KNIVES

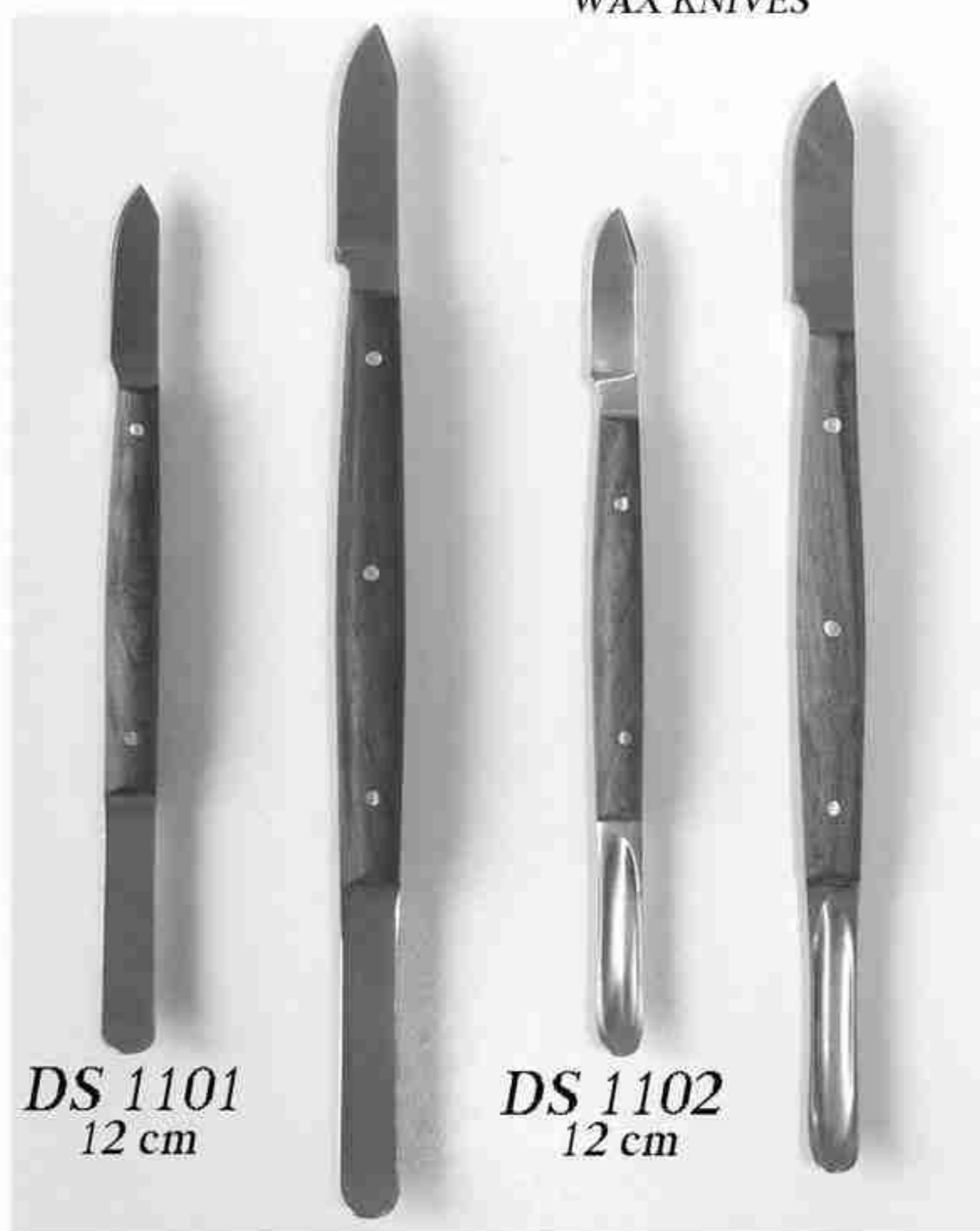

DS 1101
12 cm

DS 1102
12 cm

DS 1103
17 cm

DS 1104
17 cm

78.



GIPSZ OLLÓ
GIPSSCHERE
PLASTER CUTTING FORCEPS



DU 153

ADAPTA FOGÓ
ADAPTA ZANGE
FOIL HOLDER

KÜVETTA KENGYEL
KÜVETTENBÜGEL
FLASK CLAMP

DS 1706

DS 1705

DS 1704

Stainless

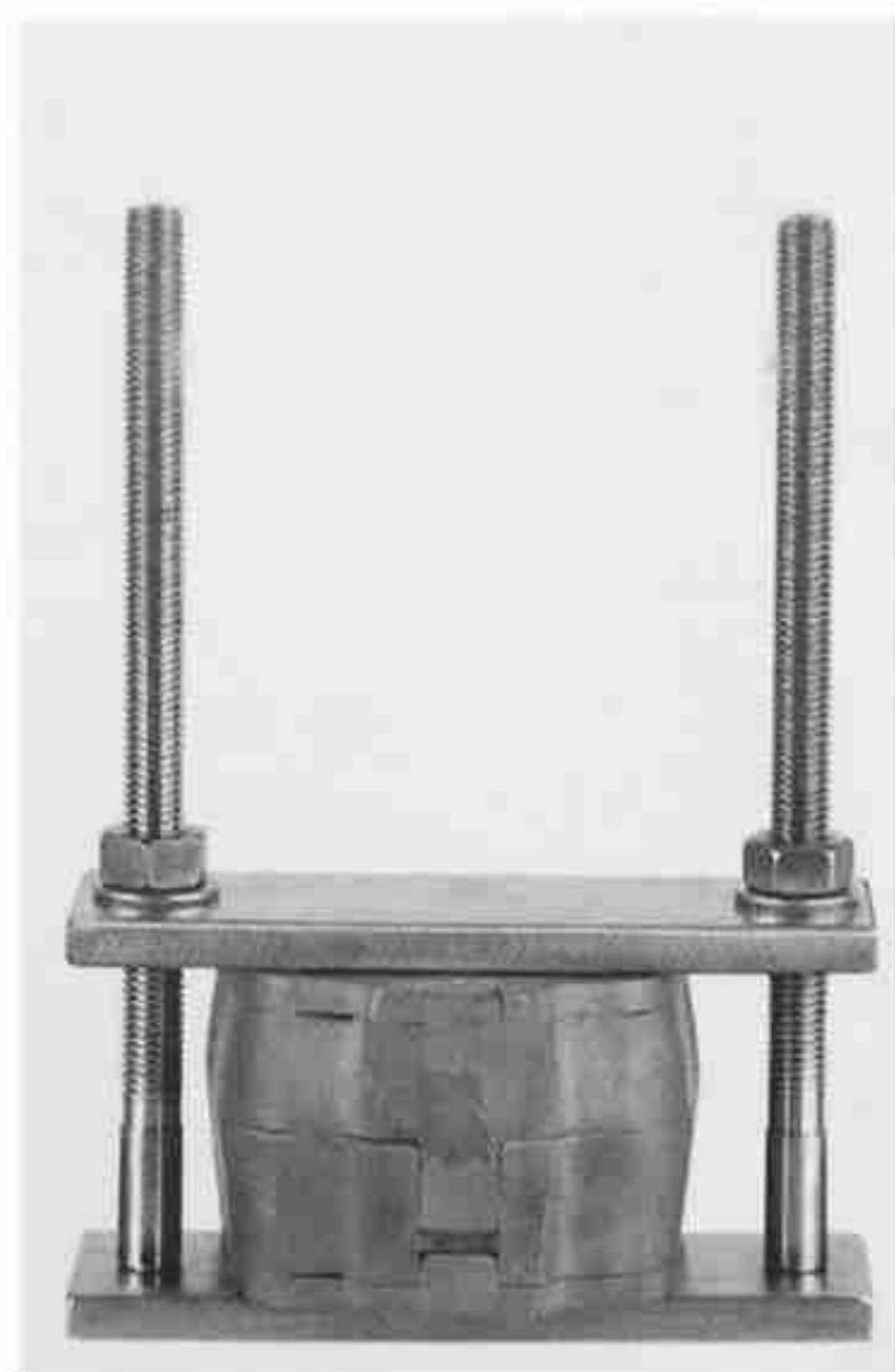

ÖNTŐGYŰRŰ FOGÓ
TIEGEL ZANGE
MOULD TONGS

DS 2400
40 cm

DS 2401
60 cm

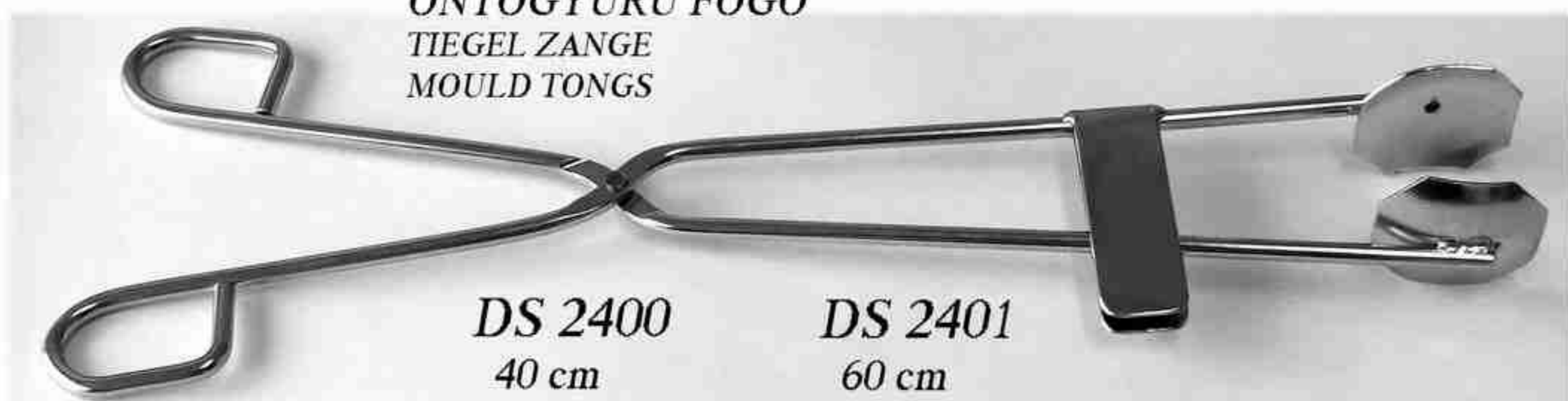



DU 151

TECHNIKAI KALAPÁCS
HAMMER FÜR ZAHNTECHNIK
TECHNICAL MALLETS

ÖNTÖGYŰRŰ - MUFFELRINGE - CASTING RINGS



$\text{Ø}30 \times 2 \times 55$
DS 2501

$\text{Ø}48.3 \times 2 \times 55$
DS 2503

$\text{Ø}63.5 \times 2 \times 55$
DS 2506



$\text{Ø}80 \times 2 \times 55$
DS 2509



DS 2500
BEÁGYAZÓ GUMITALP
MUFFEL BÖDEN
MOULD BASE SOCKET

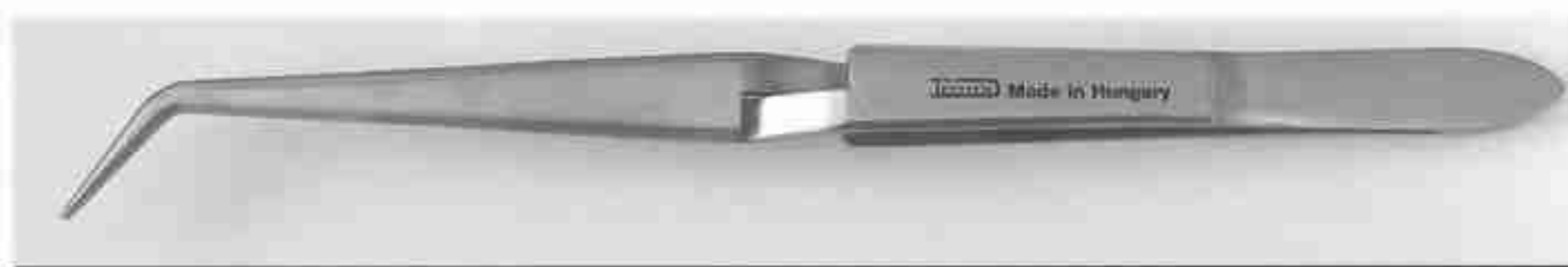

DS 2780
FORRASZTÓ CSIPESZEK
LÖTPINZETTEN
SOLDERING TWEEZERS

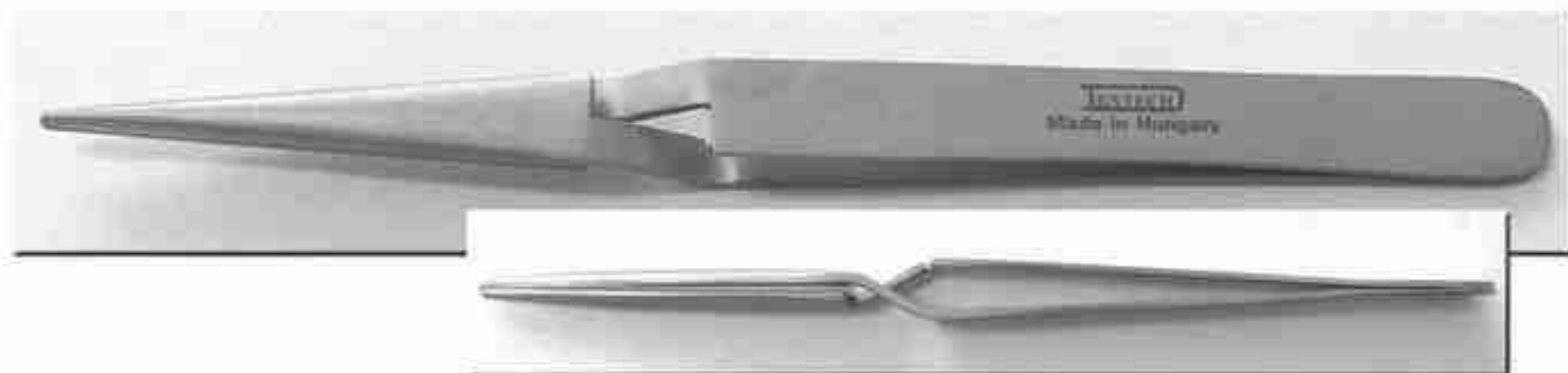

DS 2781



DS 2405

KORONA FALVASTAGSÁG MÉRŐ IWANSON
MESSZIRKEL IWANSON
CALIPER IWANSON



100 x 80 x 60
ALUMINIUM

DS 2404



95 x 70 x 50
ALUMINIUM

DS 3404

DUBLIR KÜVETTA
DUBLIR KÜVETTE
DUPLICATING FLASK

KORONA OLLÓK - KRONENSCHERE - CROWN SCISSORS



DP 1560

DP 1561

BEEBEE
11 CM



DP 1562

DP 1563

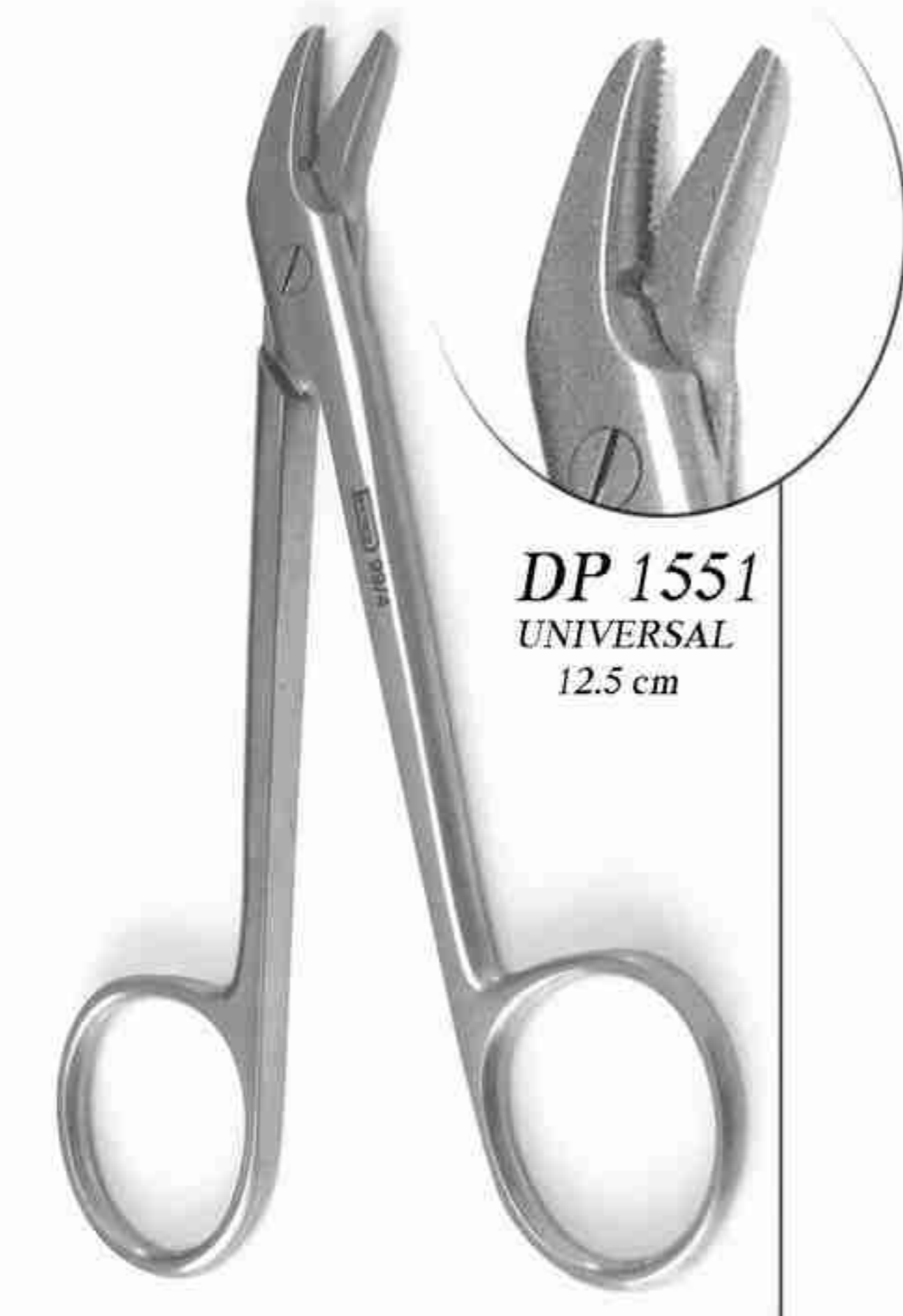

DP 1551
UNIVERSAL
12.5 cm

LENYOMATKANÁL, FÉM
 ABDRUCKLÖFFEL AUS METALL
 IMPRESSION TRAY
 STAINLESS STEEL

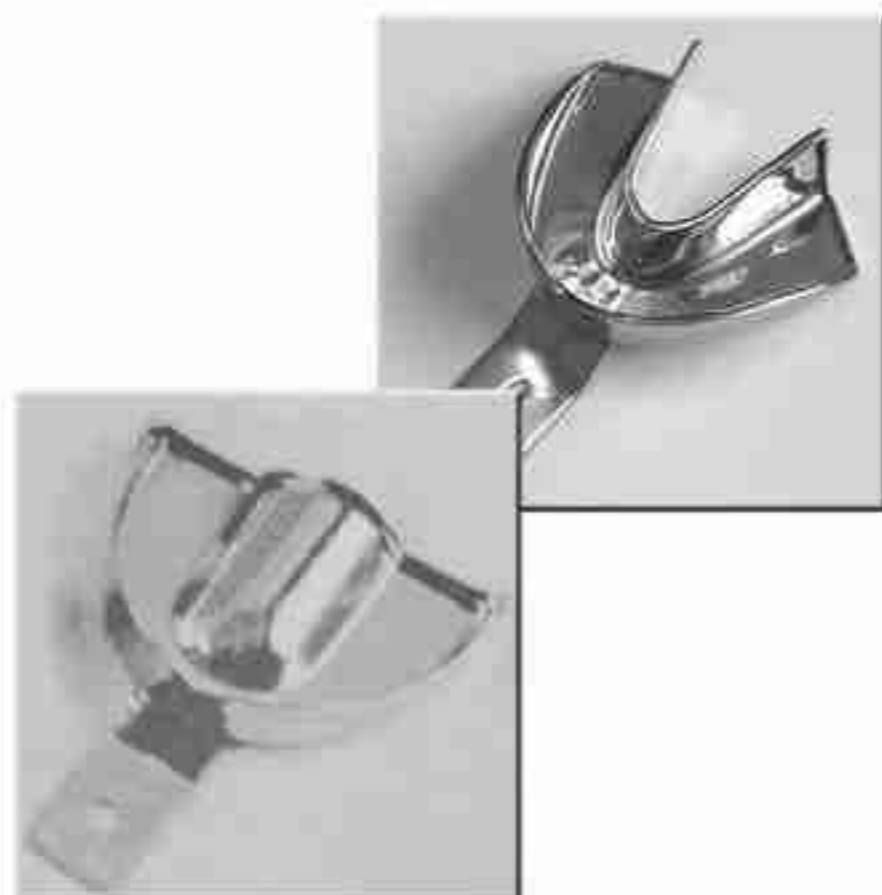

felső
 oberer
 upper

alsó
 unterer
 lower

UT 2645 XL
 UT 2646 L
 UT 2647 M
 UT 2648 S
 UT 2649 XS

LT 2650 XL
 LT 2651 L
 LT 2652 M
 LT 2653 S
 LT 2654 XS

felső
 oberer
 upper

alsó
 unterer
 lower

UT 2635 XL	LT 2640 XL
UT 2636 L	LT 2641 L
UT 2637 M	LT 2642 M
UT 2638 S	LT 2643 S
UT 2639 XS	LT 2644 XS

CEMENTKEVERŐ ÜVEGLAP - ZEMENT MISCHPLATTE AUS GLAS -
CEMENT MIXER PLATE GLASS



DF 1120
100 X 100



DF 1121
130 X 80



DD 14
40 cm

SZALVÉTATARTÓ
SERVIETTENHALTER
NAPKIN HOLDER

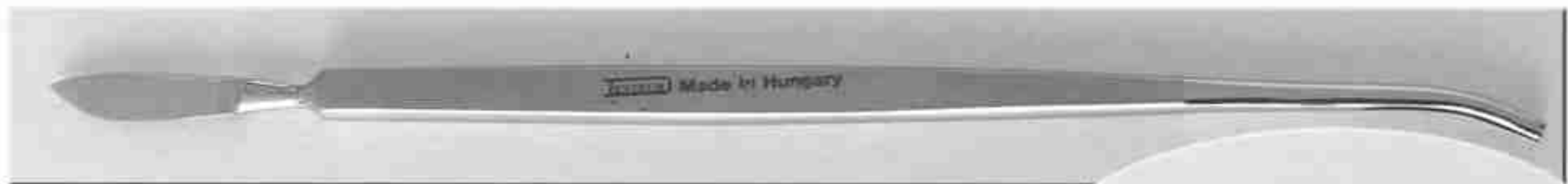

DL 101
LENYOMATVÁGÓ
ABDRUCKSCHNEIDER
IMPRESSION CUTTER



DL 100
LENYOMATVÁGÓ
ABDRUCKSCHNEIDER
IMPRESSION CUTTER



SZÁJSEBÉSZETI NYÁLSZÍVÓ, FÉM
SPEICHELSAUGER FÜR STOMATOLOGIE, METALL
SUCTION TUBE FOR STOMATOLOGY, STAINLESS STEEL



DD 12
NYÁLSZÍVÓPIPA, FÉM
SAUGENKANÜLE, METALL
SUCTION TUBE

Ø6 mm

**DZ 853**

28 x 18 x 3 cm

MÚSZERDOBOZ 20 DB-OS

INSTRUMENTEN BEHALTER

FÜR 20 STK.

INTRUMENTS BOXES FOR 20 PCS

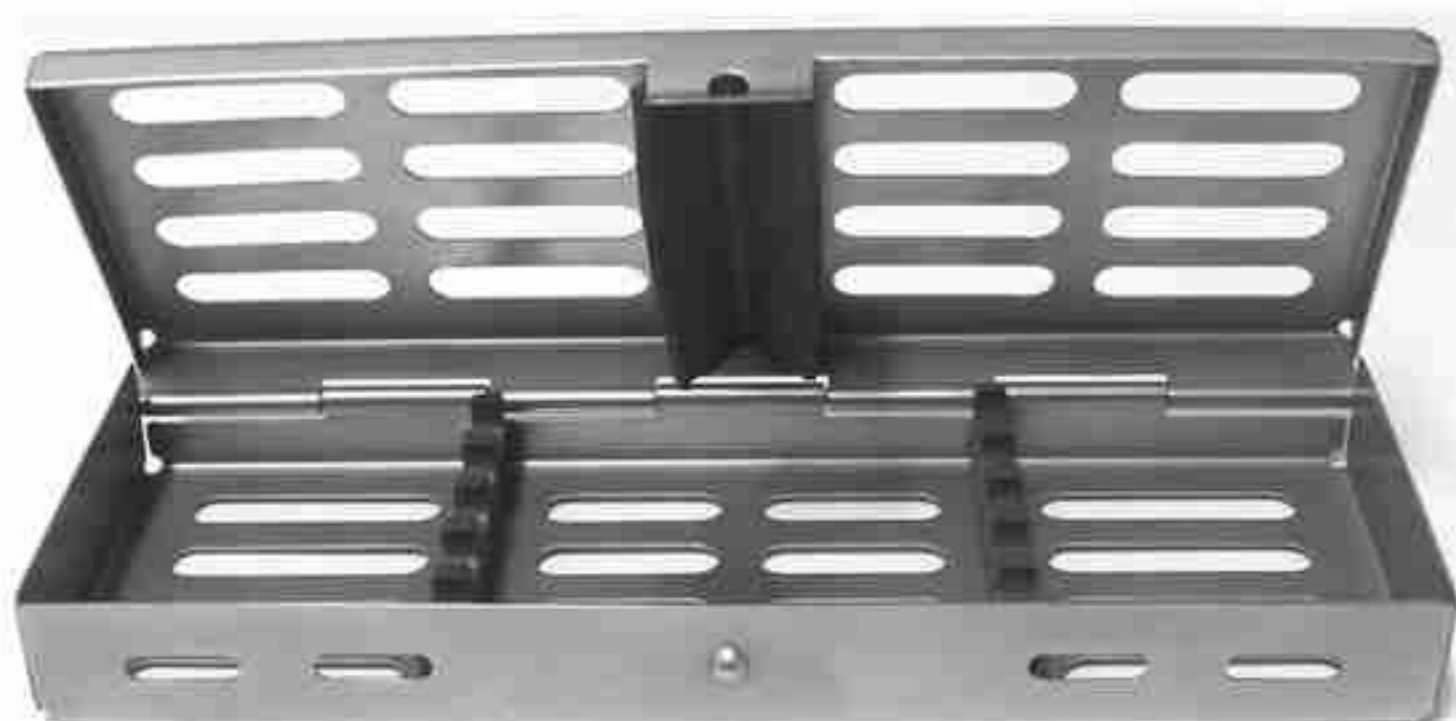
**DZ 851**

18 X 7 X 2.5 cm

MÚSZERDOBOZ 5 DB-OS

INSTRUMENTEN BEHALTER

FÜR 5 STK.

INTRUMENTS BOXES FOR 5 PCS

DZ 852

18 x 14 x 2.5 cm

MÚSZERDOBOZ 10 DB-OS

INSTRUMENTEN BEHALTER

FÜR 10 STK.

INTRUMENTS BOXES FOR 10 PCS

